



Sistema di pressurizzazione automatico con inverter

IT ISTRUZIONI PER L'USO
EN INSTRUCTIONS FOR USE
ES INSTRUCCIONES DE USO
FR MODE D'EMPLOI
DE BEDIENUNGSANLEITUNG
PT INSTRUÇÕES PARA A UTILIZAÇÃO
RU ИНСТРУКЦИЯ ПО ЭКСПЛУАТАЦИИ

MADE IN ITALY



 **PEDROLLO**[®]
the spring of life

- Automatic pressurisation system with inverter
- Sistema de pressurizacion automatico con inverter
- Système de pressurisation automatique avec onduleur
- Automatische druckbeaufschlagungsanlage mit inverter
- Sistema de pressurização automático com inversor
- Автоматическая система герметизации с инвертором



Sistema di pressurizzazione automatico con inverter

IT	ISTRUZIONI PER L'USO	4
EN	INSTRUCTIONS FOR USE	18
ES	INSTRUCCIONES DE USO	32
FR	MODE D'EMPLOI	46
DE	BEDIENUNGSANLEITUNG	60
PT	INSTRUÇÕES PARA A UTILIZAÇÃO	74
RU	ИНСТРУКЦИЯ ПО ЭКСПЛУАТАЦИИ	88

INDICE

INFORMAZIONI GENERALI.....	5
NORME DI SICUREZZA.....	5
DESCRIZIONE DEL PRODOTTO.....	6
DATI TECNICI	7
LIMITI D'IMPIEGO	7
CURVE DI PRESTAZIONE	7
SEGNALAZIONI LUMINOSE	8
INSTALLAZIONE E COLLEGAMENTI IDRAULICI	8
RIEMPIMENTO ED ACCENSIONE.....	10
REGOLAZIONE DELLA PRESSIONE DI LAVORO	12
GONFIAGGIO DEL VASO	12
SELEZIONE FUNZIONAMENTO AUTOADESCANTE	13
COLLEGAMENTI ELETTRICI SCHEDA DI ESPANSIONE.....	13
ALLARMI	14
RICERCA GUASTI	15
MANUTENZIONE	16
DIMENSIONI E PESI	17
GARANZIA	17
SMALTIMENTO.....	17
DICHIARAZIONE DI CONFORMITÀ	17

INFORMAZIONI GENERALI

Istruzioni originali per l'uso.

Il presente manuale deve sempre accompagnare l'apparecchio a cui si riferisce ed essere conservato in un luogo accessibile e consultabile dalle persone addette all'uso ed alla manutenzione del sistema.

Si raccomanda all'installatore/utilizzatore di leggere attentamente le prescrizioni e le informazioni contenute nel presente manuale prima di utilizzare il prodotto, al fine di evitare il danneggiamento, l'utilizzo improprio dell'apparecchiatura o la perdita della garanzia.

Questo prodotto non deve essere utilizzato da bambini o da persone con capacità fisiche, sensoriali o mentali ridotte, o con una mancanza di esperienza e conoscenza, se non sono stati dati supervisione ed istruzione. I bambini dovrebbero essere osservati in modo da assicurarsi che non giochino con l'apparecchio.

La ditta costruttrice declina ogni responsabilità in caso di incidente o danno dovuti a negligenza o alla mancata osservanza delle istruzioni descritte in questo opuscolo o in condizioni diverse da quelle indicate in targa. Declina altresì ogni responsabilità per danni causati da un uso improprio dell'elettropompa. Non sovrapporre pesi o altre scatole all'imballo.

NORME DI SICUREZZA

Nel presente manuale sono stati usati dei simboli che hanno il seguente significato.



Questo simbolo avverte che la mancata osservanza della prescrizione comporta un rischio di scosse elettriche.



Questo simbolo avverte che la mancata osservanza della prescrizione comporta un rischio di danno a persone o cose.



PRIMA DI INSTALLARE E UTILIZZARE IL PRODOTTO:

- leggere attentamente il presente manuale in tutte le sue parti;
- controllare che i dati di targa siano quelli desiderati ed adeguati all'impianto;
- l'installazione e la manutenzione devono essere eseguite da personale qualificato, responsabile di eseguire i collegamenti elettrici secondo le regole di installazione nazionali;
- il produttore declina ogni responsabilità per danni deri-

vanti da uso improprio del prodotto e non è responsabile di danni causati da manutenzioni o riparazioni eseguite da personale non qualificato e/o con parti di ricambio non originali;

- l'utilizzo di ricambi non originali, manomissioni o usi impropri, fanno decadere la garanzia sul prodotto.



IN FASE DI PRIMA ISTALLAZIONE ED IN CASO DI MANUTENZIONE ASSICURARSI CHE:

- non ci sia tensione sulla rete di alimentazione elettrica.
- la rete di alimentazione elettrica sia dotata di protezioni ed in particolare di interruttore differenziale ad alta sensibilità (30 mA in classe A) idoneo a proteggere da correnti di guasto di tipo alternato, unipolare pulsante, continuo, ad alta frequenza. Verificare inoltre che la messa a terra sia conforme alle norme.
- prima di rimuovere il coperchio del DG PED o iniziare interventi su di esso, è necessario scollegare l'impianto dalla rete elettrica ed attendere almeno 5 minuti affinché i condensatori abbiano il tempo di scaricarsi mediante i resistori di scarica incorporati.



ATTENZIONE: in stato di fuori servizio (LED rosso acceso) DG PED rimane in tensione; prima di qualsiasi intervento è obbligatorio togliere la tensione dal gruppo.



ARRESTO DI EMERGENZA

- Mentre DG PED è in funzione, è possibile eseguire un arresto di emergenza, premendo il tasto I/O.
- Nelle applicazioni con due unità in parallelo è solo l'inverter MASTER che blocca il sistema.



In fase di prima installazione e di manutenzione, assicurarsi che NON CI SIA TENSIONE sulla rete elettrica.



In fase di prima installazione e di manutenzione, assicurarsi che l'impianto NON SIA IN PRESSIONE.



NON APRIRE I COPERCHI DELL'INVERTER eccetto del coperchio connettori.

DESCRIZIONE DEL PRODOTTO

DG PED è un sistema di pressurizzazione automatico con inverter composto da: un'elettropompa autoadescante ad alta efficienza, un vaso di accumulo, i sensori di pressione e di flusso, una valvola di non ritorno.

Un vero e proprio sistema di pompaggio compatto, silenzioso e performante.

Un sofisticato controllo elettronico ad inverter controlla in maniera intelligente ed intuitiva l'intero sistema:

- mantiene costante la pressione di impianto regolando la velocità della pompa in funzione della richiesta idrica;
- controlla i parametri di funzionamento idraulici ed elettrici e protegge l'elettropompa dalle anomalie;
- può essere dotato di scheda di espansione che permette di lavorare in parallelo con altri DG PED gestendo segnali in ingresso e di uscita;
- si adatta ad ogni tipologia di impianto di pressurizzazione, anche esistente. Ove la normativa lo consenta, l'apparec-

chio è adatto all'utilizzo su rete idrica. In questo caso inserire una valvola di non ritorno a monte;

- limita le correnti di spunto e di funzionamento per un maggior risparmio energetico.

Nelle applicazioni in parallelo, si distinguono un inverter **MASTER** ed inverter **SLAVE**, controllati dal MASTER.

Il MASTER riceve la programmazione dei parametri e controlla i dati di funzionamento, ed attiva e disattiva gli SLAVE secondo le necessità.



Se il MASTER viene spento, gli SLAVE tornano ad essere autonomi e continuano a funzionare indipendentemente.

Quando lavora in configurazione parallela con altri inverter, DG PED gestisce l'alternanza degli avviamenti, per uniformare l'utilizzo delle pompe.

ELENCO DELLE PARTI

1. Interruttore generale bipolare I/O
2. Passacavi segnali INPUT/OUTPUT
3. Pannello di controllo
4. Tappo di carico
5. Tappo vaso di espansione
6. Tappo di sfiato
7. Tappo di scarico
8. Scheda di espansione (OPTIONAL)
9. Fusibile 12.5 A (ad intervento rapido)
10. Forcella di bloccaggio connettore
11. Raccordo a gomito orientabile, con OR
12. Bocca di mandata (OUT)
13. Bocca di aspirazione (IN)
14. Piedini antivibranti
15. Cavo di alimentazione

PANNELLO DI CONTROLLO

16. Tasto accensione / spegnimento 
17. Indicatori LED di colore verde che segnalano:
 - pompa in marcia;
 - pressione di lavoro;
 - allarmi
18. Indicatori LED di colore verde o rosso
19. Tasti  e  di incremento valori

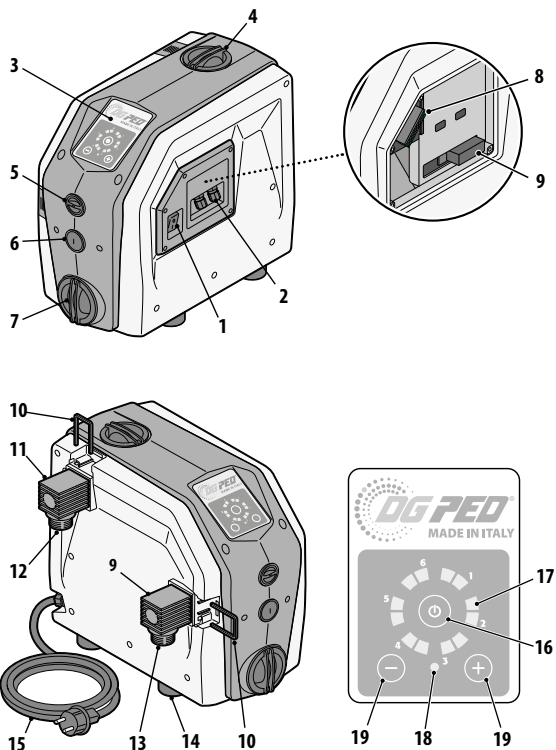

DATI TECNICI

- Tensione di alimentazione ~ **230 V** ± 10%
- Frequenza **50/60 Hz**
- Isolamento: **classe F**
- Corrente massima assorbita
 - **7.5 A** DG PED 3
 - **10 A** DG PED 5
- P₁ Potenza massima assorbita:
 - **1.0 kW** DG PED 3
 - **1.5 kW** DG PED 5
- Protezione **IP X4**
- Set point di fabbrica **3 bar**
- Fusibile **12.5 A** (ad intervento rapido)

LIMITI D'IMPIEGO

- Altezza d'aspirazione manometrica fino a **8 m**
- Temperatura del liquido da **0 °C** fino a **+40 °C**
- Temperatura ambiente da **0 °C** fino a **+40 °C**
- Pressione max **10 bar**
- Servizio continuo **S1**
- Posizione di lavoro verticale



CURVE DI PRESTAZIONE

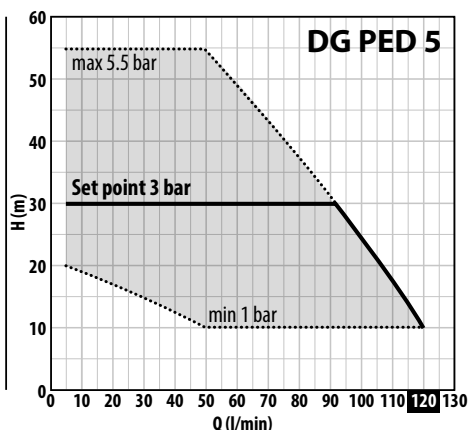
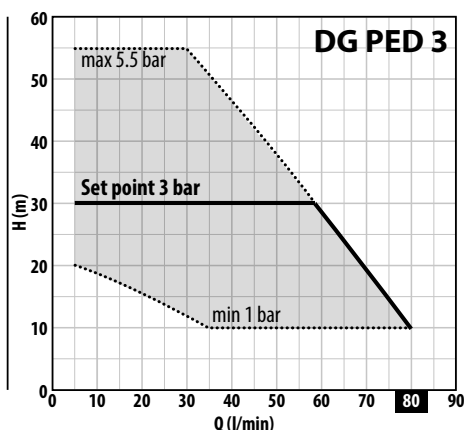

TIPO	POTENZA		PRESTAZIONI MAX		PRESTAZIONI (SET POINT REGOLABILE)					
	P2		Q	H	Set Point Min		Set Point Taratura Std		Set Point Max	
	kW	HP			bar	l/min	bar	l/min	bar	l/min
Monofase			l/min	metri	bar	l/min	bar	l/min	bar	l/min
DG PED 3	0.75	1								
DG PED 5	1.1	1.5	5 – 120	55 – 10	1	50 – 120	3	5 – 92	5.5	5 – 50

Q = Portata H = Prevalenza manometrica totale Tolleranza delle curve di prestazione secondo EN ISO 9906 Grado 3B.

▲ Classe di rendimento del motore trifase (IEC 60034-30-1)

Le prestazioni indicate sono riferite ad un battente in aspirazione pari a -1 m (aspirazione da 1 m). Se il livello dell'acqua in aspirazione è inferiore alla quota di imbocco della pompa, le prestazioni saranno ridotte corrispondentemente.

SEGNALAZIONI LUMINOSE

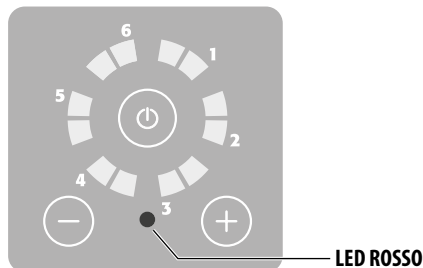

FUORI SERVIZIO

DG PED è in tensione ma è fuori servizio

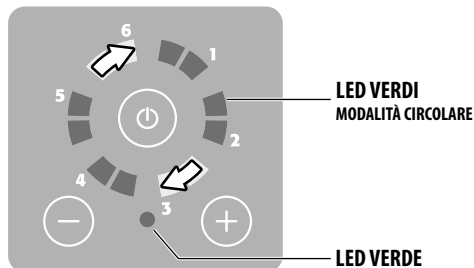

POMPA IN MARCIA

DG PED è in tensione e la pompa è in marcia

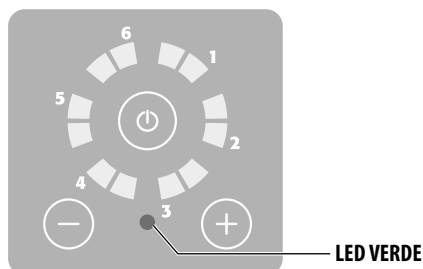

STAND-BY

DG PED è in tensione ma la pompa non è in marcia

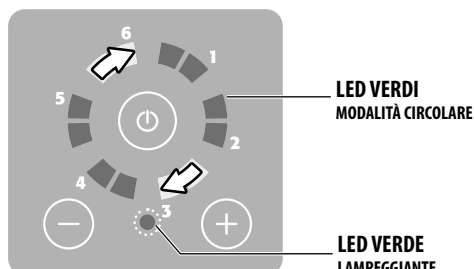

POMPA IN FASE DI ARRESTO

DG PED è in tensione e la pompa è in fase di arresto

INSTALLAZIONE E COLLEGAMENTI IDRAULICI (solo per personale qualificato)



In fase di prima installazione e di manutenzione, assicurarsi che **NON CI SIA TENSIONE** sulla rete elettrica.



In fase di prima installazione e di manutenzione, assicurarsi che l'impianto **NON SIA IN PRESSIONE**.

Assicurarsi che la rete di alimentazione elettrica sia dotata di protezioni ed in particolare di interruttore differenziale ad alta sensibilità (30 mA in classe A) idoneo a proteggere da correnti di guasto di tipo alternato, unipolare pulsante, continuo, ad alta frequenza. Verificare inoltre che la messa a terra sia conforme alle norme.

Verificare che i dati di targa siano quelli desiderati ed adeguati all'impianto.

Installare DG PED in un locale:

- protetto dagli agenti esterni;
- areato, esente da umidità eccessiva o polveri eccessive;
- in modo che non riceva vibrazioni nocive o sforzi meccanici dalle tubazioni collegate.

- 1 Regolare i piedini per livellare correttamente il DG PED.

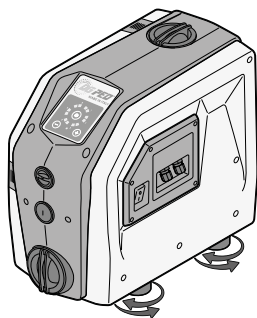

- 2 Rimuovere i coperchi forcella.

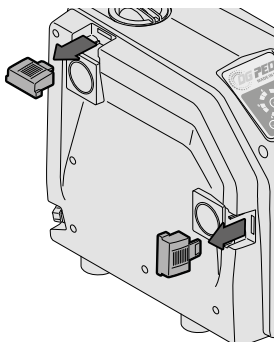

- 3 Rimuovere le forcelle.

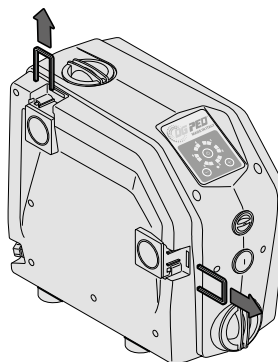

- 4 Inserire i raccordi a gomito completi di O-RING.

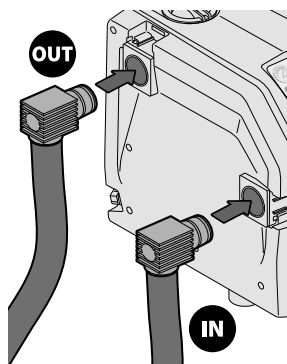

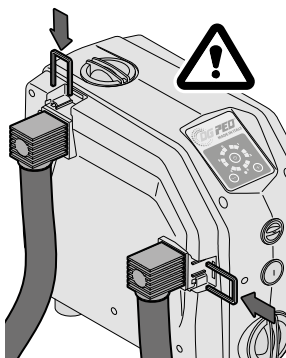

 Il tubo di aspirazione deve avere un diametro minimo di 1" ed essere perfettamente sigillato.

- 5 Inserire correttamente le forcelle.

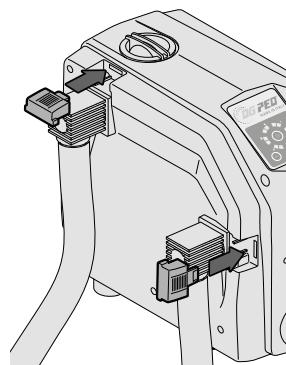

- 6 Inserire i coperchi forcella.



 È possibile aggiungere all'impianto un vaso di espansione, installato sul lato in mandata (OUT).

RIEMPIMENTO ED ACCENSIONE (solo per personale qualificato)

! Non fare mai funzionare DG PED a secco, per non danneggiare la tenuta meccanica.

CASO A: funzionamento SOTTO BATTENTE (serbatoio o acquedotto)

1 Aprire tutte le valvole per riempire la pompa di acqua.

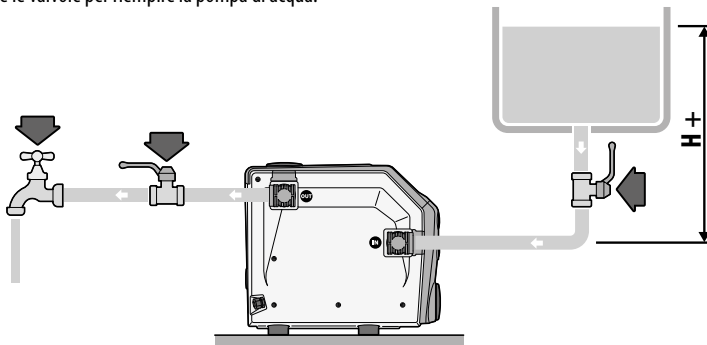

2 Collegare la spina alla rete elettrica.

3 Portare l'interruttore su "I".

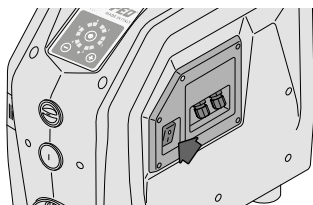

4 Premere il tasto  per avviare DG PED.



CASO B: funzionamento SOPRA BATTENTE (pescaggio da vasca o da pozzo)

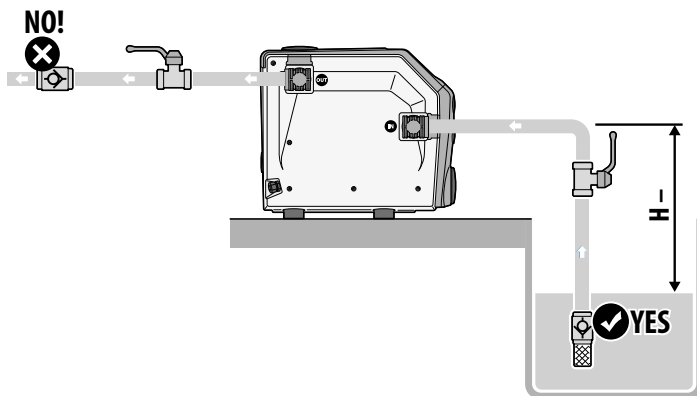

- 1 Svitare e togliere il tappo di carico e il tappo di sfiato.
- 2 Versare circa 1.5 litri di acqua fino alla fuoriuscita dal foro di sfiato.
- 3 Riavvitare il tappo di carico e il tappo di sfiato.
- 4 Aprire il rubinetto dell'acqua.

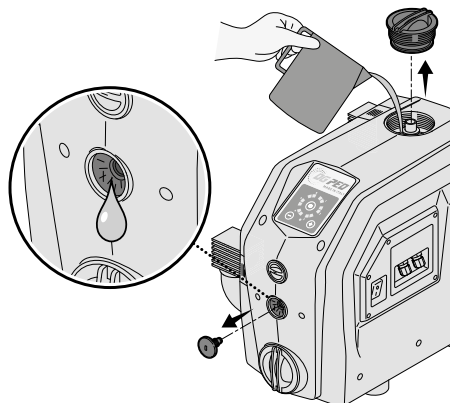

- 5 Collegare la spina alla rete elettrica.
- 6 Portare l'interruttore su "I".

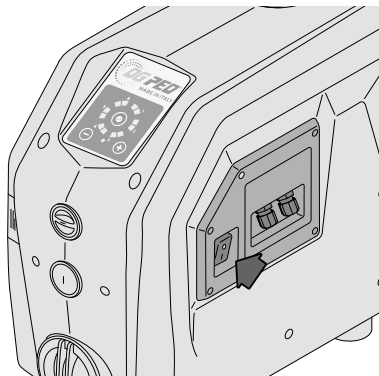

- 7 Premere CONTEMPORANEAMENTE i tasti ⊕ e ⊖ per 5 secondi. DG PED entra nella modalità adescamento.

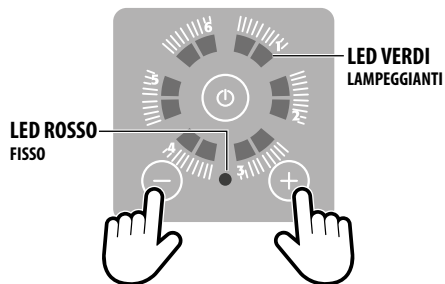

- 8 Premere il tasto ⏻ per avviare l'adescamento.

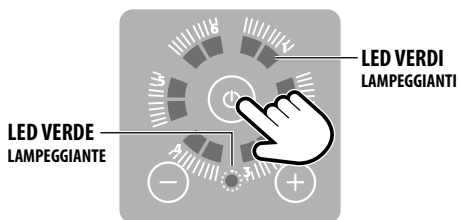

La procedura di adescamento dura al massimo 5 minuti, allo scadere di ogni minuto DGPED automaticamente arresta l'elettropompa per 5 secondi e la riavvia scaduti gli stessi. E così via per tutto il tempo che DGPED rimarrà in adescamento. Durante questa procedura i led continueranno a lampeggiare.

L'uscita dalla procedura di adescamento, può avvenire o per time out (5 minuti) o per fase adescamento completata. I led smetteranno di lampeggiare. Se la pompa non dovesse adescare ripetere nuovamente l'operazione da capo.

REGOLAZIONE DELLA PRESSIONE DI LAVORO

La PRESSIONE DI LAVORO viene visualizzata attraverso i LED di colore verde che si illuminano sul pannello di controllo.

La PRESSIONE DI LAVORO del DG PED va da un minimo di 1 bar ad un massimo di 5.5. bar

Per la regolazione:

- Premere il tasto **+** per visualizzare la PRESSIONE DI LAVORO
 - Premere i tasti **+** o **-** per aumentare o diminuire la PRESSIONE DI LAVORO.
- Ad ogni pressione del tasto **+** o **-** si incrementa o decrementa il valore a step di 0.5 bar.

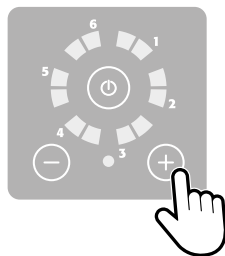

Esempio

Premere il tasto **+** per visualizzare la PRESSIONE DI LAVORO

Con i led verdi accesi come illustrato in figura, la pressione di lavoro è di **2 bar**.

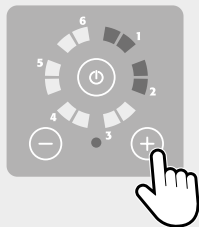

Per portare la pressione di lavoro ad esempio a 3 bar premere due volte il tasto **+**.

Il valore si incrementa di 1 bar (0.5+0.5 bar).

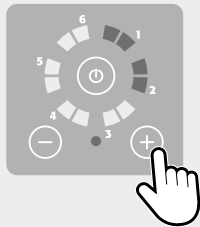

I led si accendono come illustrato in figura. Pressione di lavoro **3 bar**.



GONFIAGGIO DEL VASO (solo per personale qualificato)

Il vaso d'espansione all'interno del DG PED è precaricato di fabbrica a 1.5 bar.

Il gonfiaggio ottimale del vaso garantisce il perfetto funzionamento del sistema e preserva da rotture precoci della membrana.

⚠ Il gonfiaggio del vaso deve avvenire con pressione di impianto nulla. Pressione massima di gonfiaggio 4 bar.

⚠ Gonfiare il vaso d'espansione come da tabella. Per pressioni di lavoro inferiori a 3 bar, gonfiare il vaso di 0.5 bar in meno della pressione di lavoro.

**Esempio: pressione di lavoro = 2 bar,
pressione di gonfiaggio = 1.5 bar**

Per gonfiare il vaso d'espansione:

- Togliere il tappo.
- Munirsi di un compressore.
- Collegare il tubo del compressore alla valvola di carico.
- Gonfiare il vaso d'espansione alla pressione desiderata.

⚠ Verificare almeno una volta all'anno la pressione di gonfiaggio del vaso. Se necessario ripristinarla al valore previsto.

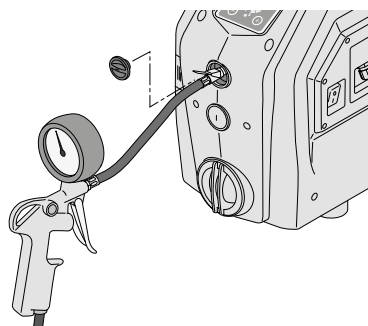

Pressione di lavoro	Pressione di gonfiaggio
3.0 bar	1.5 bar
3.5 bar	2.0 bar
4.0 bar	2.5 bar
4.5 bar	3.0 bar
5.0 bar	3.5 bar
5.5 bar	4.0 bar

SELEZIONE FUNZIONAMENTO AUTOADESCANTE (solo per personale qualificato)

La pompa esce di fabbrica in versione AUTOADESCANTE; nel caso sia garantito il funzionamento sottobattente o l'alimentazione sia già in pressione, è possibile escludere la funzione di auto-adesamento, ruotando la leva mostrata sotto in posizione verticale.

- 1 Svitare e togliere il tappo di scarico.
Possibile uscita di acqua.

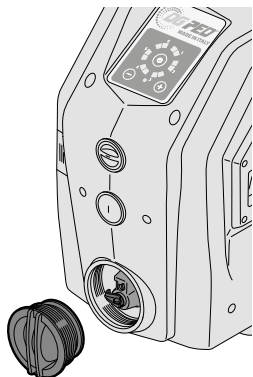

- 2 Ruotare la leva rossa in posizione verticale per escludere il funzionamento autoadesante.

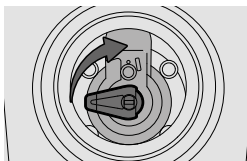

AUTOADESCANTE
(settaggio di fabbrica)

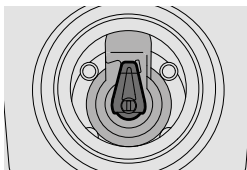

NON AUTOADESCANTE

- 3 Riavvitare il tappo di scarico e riempire d'acqua nuovamente DG PED come indicato nel capitolo RIEMPIMENTO ED ACCENSIONE.

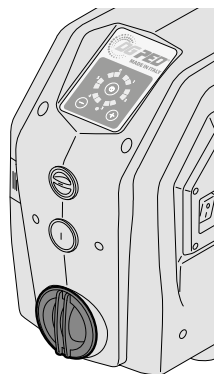

OPTIONAL

COLLEGAMENTI ELETTRICI SCHEDA DI ESPANSIONE (solo per personale qualificato)

 Assicurarsi che **NON CI SIA TENSIONE** sulla rete elettrica.

ATTENZIONE: qualunque dispositivo connesso alla scheda di espansione deve essere in bassissima tensione di sicurezza (SELV).

 Durante la rimozione del coperchio non tirare i cavi elettrici collegati all'interruttore generale.

- Svitare e togliere le viti di fissaggio coperchio.
- Rimuovere parzialmente il coperchio per accedere alla morsettiera della scheda di espansione.

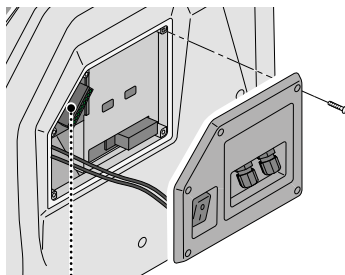

LEGENDA MORSETTIERA

- | | | |
|------|--------|--|
| 1-2 | INPUT | SEGNALE DI LIVELLO - ponticellare in assenza di segnale |
| 3-4 | OUTPUT | SEGNALE DI ALLARME - max 0,3 A @ 230 Va.c. / 1A @ 30 Vd.c. |
| 5-6 | RS 485 | comunicazione MASTER / SLAVE |
| 7-8 | 0V | non connesso |
| 9-10 | SLAVE | se ponticellato, l'inverter diventa SLAVE |

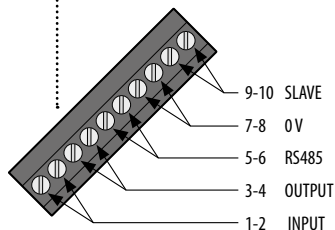

ALLARMI

LED VERDE LAMPEGGIANTE + LED ROSSO LAMPEGGIANTE

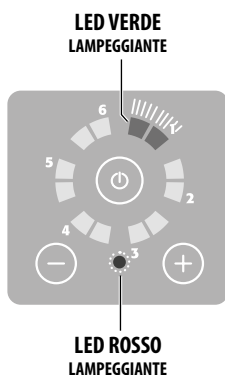

- ALARM 1** = Marcia a secco. Interviene dopo 7 sec. di assenza di acqua in aspirazione. Controllare la presenza di acqua in aspirazione e riempire la pompa. DG PED effettua tentativi automatici di ripartenza dopo 1 min, 15 min, 30 min, 1h, 1h, etc.
- ALARM 2** = La pompa non raggiunge la pressione impostata. Contattare un centro di assistenza.
- ALARM 3** = La pressione di pre-carica del vaso è troppo bassa; gonfiare il vaso al 50% della pressione di lavoro (ad es. se lavoro a 3 bar, gonfiare il vaso a 1.5 bar).
- ALARM 4** = Pressione in mandata inferiore a 0,2 bar (tubo rotto). Il riarmo è solo manuale. Verificare perchè la pressione si è azzerata.
- ALARM 5** = Voltaggio di alimentazione troppo basso. Garantire 230V +/- 10% in alimentazione.
- ALARM 6** = Segnale di OFF da esterno.

LED VERDE FISSO + LED ROSSO LAMPEGGIANTE

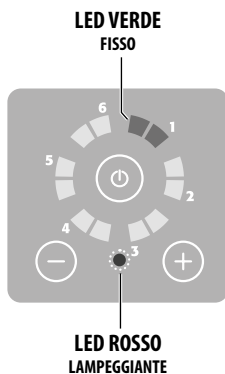

- ALARM 1** = Corto circuito. Spegner il dispositivo e contattare un centro di assistenza. Il riarmo è solo manuale.
- ALARM 2** = Sovracorrente. La corrente assorbita eccede la tolleranza permessa. Il riarmo è solo manuale. Se il problema persiste, contattare un centro di assistenza.
- ALARM 3** = Eccessiva temperatura del modulo. Controllare la temperatura del liquido pompato. Se il liquido non ha una temperatura maggiore di 40 °C contattare un centro di assistenza. Riarmo automatico se la temperatura scende sotto il valore di allarme.
- ALARM 4** = Eccessiva temperatura del motore. Controllare la temperatura del liquido pompato. Se il liquido non ha una temperatura superiore ai 40 °C, contattare un centro di assistenza. Riarmo automatico se la temperatura scende sotto il valore di allarme.
- ALARM 5** = Segnale del sensore di pressione non valido. Contattare un centro assistenza.
- ALARM 6** = Segnale del sensore di flusso non valido. Contattare un centro assistenza

Esempio: pompa in allarme per MARCIA A SECCO

LED 1 LAMPEGGIANTE
+
LED ROSSO LAMPEGGIANTE
=
MARCIA A SECCO

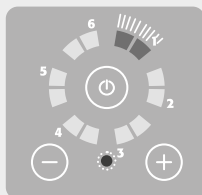

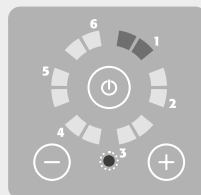

Esempio: pompa in allarme per CORTO CIRCUITO

LED 1 FISSO
+
LED ROSSO LAMPEGGIANTE
=
CORTO CIRCUITO



RICERCA GUASTI

PROBLEMA	SEGNALAZIONE LED	INTERVENTO
La tastiera non si accende.	LED spenti.	Verificare che l'interruttore laterale sia in posizione "I".
		 Verificare presenza di alimentazione elettrica dalla rete, verificare l'adeguatezza dell'interruttore differenziale.
La pompa non si avvia all'apertura di un'utenza.	LED rosso acceso fisso.	Portare in servizio la pompa premendo il tasto "I/O".
	LED rosso acceso lampeggiante.	Vedere elenco allarmi alle pagine precedenti.
	LED verde acceso fisso.	La pressione di impianto non scende sotto alla pressione di lavoro impostata.
Allarme di MARCIA A SECCO.	LED rosso lampeggiante, LED verdi in pos. 1 lampeggianti.	Verificare la presenza di acqua in aspirazione. Verificare che l'aspirazione non sia ostruita. Riempire ed adescare la pompa.
Allarme di CORTO CIRCUITO.	LED rosso lampeggiante, LED verdi in pos. 1 fissi.	 Verificare che la pompa non sia bloccata aprendo il tappo posteriore del motore e ruotando l'albero.
		 Verificare che il cavo, la spina e la presa siano integri e non vi siano dispersioni.
Allarme di TENSIONE BASSA.	LED rosso lampeggiante, LED verdi in pos. 5 lampeggianti.	La tensione è inferiore al valore di targa di oltre il 10%; stabilizzare la tensione per mantenerla entro i limiti +/- 10%.
La pompa si arresta e si riavvia in continuo	LED in condizione di normale funzionamento	Controllare che la pressione di gonfiaggio del vaso sia corretta. Cercare ed eliminare le perdite nell'impianto.

MANUTENZIONE (solo per personale qualificato)

ISPEZIONE E PULIZIA DELLA VALVOLA DI NON RITORNO

La VALVOLA DI NON RITORNO è posizionata all'interno della bocca di aspirazione.

Per la rimozione:

- 1 Togliere pressione all'impianto.
- 2 Rimuovere il coperchio e la forcella (A).
- 3 Rimuovere il raccordo a gomito (B).

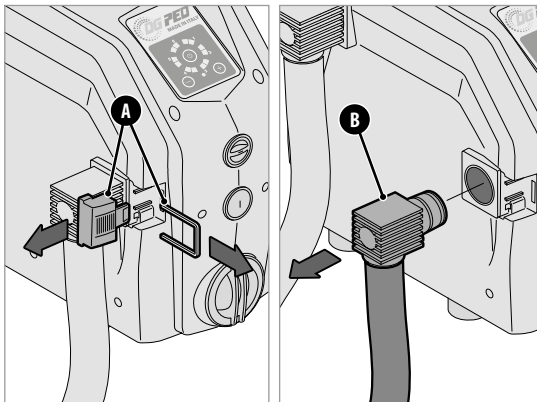

- 4 Estrarre la VALVOLA DI NON RITORNO (C).
- 5 Ispezionare / pulire la VALVOLA DI NON RITORNO (C).
- 6 Rimontare correttamente in sede la VALVOLA DI NON RITORNO (C).
- 7 Rimontare correttamente il gomito (B), la forcella e il coperchio (A).

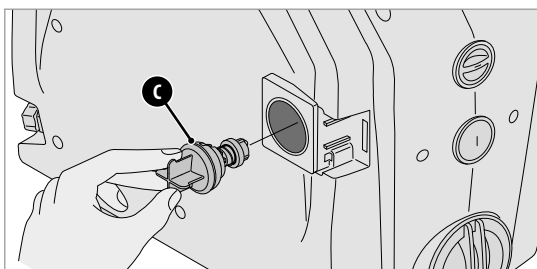

ISPEZIONE E PULIZIA DELLA VALVOLA DI FLUSSO

- 1 **Dopo aver tolto pressione all'impianto,** svitare e togliere il TAPPO DI CARICO (D).
- 2 Rimuovere il gruppo VALVOLA DI FLUSSO (E) svitando la vite di fissaggio. Ispezionarla / pulirla.
- 3 Montare il gruppo VALVOLA DI FLUSSO (E). Attenzione all'orientamento! Riavvitare la vite di fissaggio.
- 4 Avvitare correttamente il TAPPO DI CARICO (D).

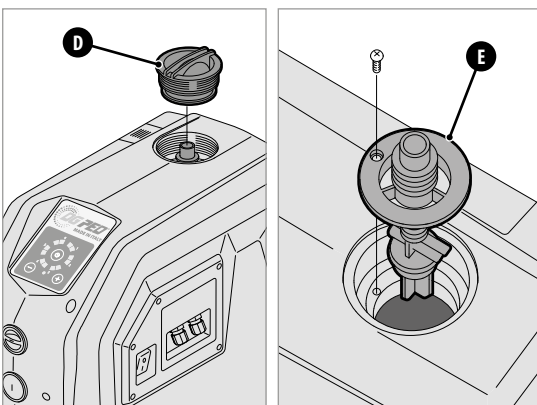

DIMENSIONI (mm)

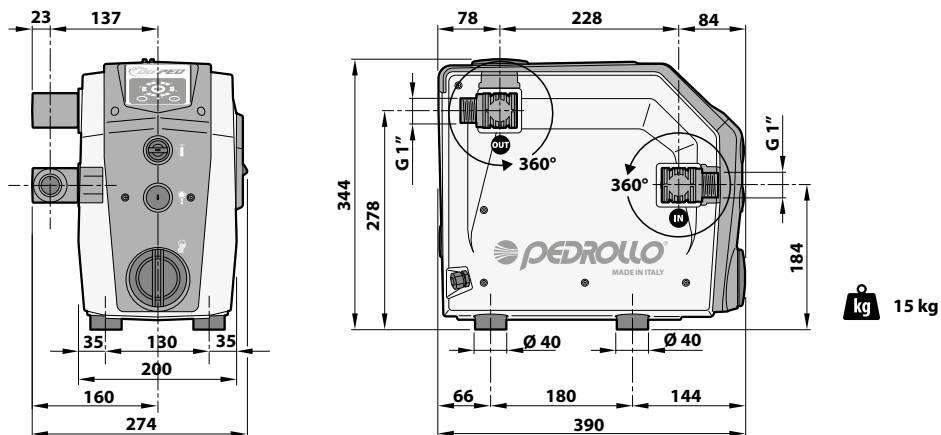

GARANZIA

Prima di installare e utilizzare il prodotto leggere attentamente il presente manuale in tutte le sue parti. L'installazione e la manutenzione devono essere eseguite da personale qualificato, responsabile di eseguire i collegamenti idraulici e elettrici secondo le applicabili norme vigenti.

Il produttore declina ogni responsabilità per danni derivanti da uso improprio del prodotto e non è responsabile di danni causati da manutenzioni o riparazioni eseguite da personale non qualificato e/o con parti di ricambio non originali. L'utilizzo di ricambi non originali, manomissioni o usi impropri, fanno decadere la garanzia sul prodotto.

SMALTIMENTO

Per lo smaltimento dei particolari che compongono il DG PED attenersi alle norme e leggi in vigore nei paesi dove viene utilizzato il gruppo.

Non disperdere parti inquinanti nell'ambiente.



**Corretto smaltimento dei RAEE
(DIRETTIVA 2012/19/UE)**

DICHIARAZIONE DI CONFORMITÀ



Dichiariamo, sotto la nostra esclusiva responsabilità, che il prodotto in oggetto risulta in conformità con quanto previsto dalle seguenti Direttive Comunitarie, comprese le ultime modifiche, e con la relativa legislazione nazionale di recepimento:

2006/42/EU, 2014/35/EU, 2014/30/EU, 2009/125/EU, 547/2012/EU, 2011/65/EU, 2015/863/EU, 1907/2006/EU, 2012/19/UE
UK legislation: 2008 No. 1597, 2016 No. 1101, 2016 No. 1091, 2019 No. 539, 2012 No. 3032

San Bonifacio, 25/02/2022

Pedrollo S.p.A.
Il Presidente
Silvano Pedrollo

CONTENTS

GENERAL INFORMATION 19

SAFETY REGULATIONS 19

DESCRIPTION OF THE PRODUCT 20

TECHNICAL DATA 21

APPLICATION LIMITS 21

CHARACTERISTIC CURVES 21

LUMINOUS SIGNALS 22

INSTALLATION AND HYDRAULIC CONNECTIONS 22

FILLING AND SWITCHING ON 24

REGULATION OF THE WORKING PRESSURE 26

INFLATION UP OF THE VASE 26

SELECTION OF SELF-PRIMING FUNCTION 27

ELECTRIC ATTACHMENTS TO THE EXPANSION CARD 27

ALARMS 28

TROUBLE SHOOTING 29

MAINTENANCE 30

DIMENSIONS 31

GUARANTEE 31

DISPOSAL 31

DECLARATION OF CONFORMITY 31

GENERAL INFORMATION

Original instructions for use.

This manual must always accompany this device and it must be kept in an accessible place so that the users and those responsible for its maintenance can consult it.

It is recommended that the installer/user should carefully read the specifications and the information contained in the present manual before using the product in order to avoid damage, the improper use of the equipment or the forfeiture of the guarantee.

This product must not be used by children or by persons with a reduced physical, sensory or mental capacity, or by those who lack experience or knowledge, if they have not received the necessary supervision and instruction. Care must be taken to avoid children playing with the device.

The manufacturer does not accept any responsibility in the event of accidents or damage caused by negligence or non-compliance with the instructions contained in this brochure or in conditions which differ from those set out below. Also it does not accept any responsibility for damage caused by the improper use of the pump.

Do not place any weights or other boxes on top of the package.

SAFETY REGULATIONS

In this manual symbols with the following meaning have been used.



This symbol warns that non-compliance with the specifications brings with it the risk of electric shocks.



This symbol warns that non-compliance with the specifications brings with it the risk of harm to persons or damage to property.



BEFORE INSTALLING AND USING THE PRODUCT:

- carefully read this manual in all its parts;
- check that the data on the registration plate are those wanted and suitable for the device;
- installation and maintenance must be carried out by qualified personnel responsible for establishing the electrical connections in accordance with the local rules of installation;

- the manufacturer does not accept any responsibility for damage caused by maintenance or repairs carried out by unqualified personnel and /or by spare parts which are not original;
- the use of spare parts which are not original, tampering or misuse will result in the forfeiture of the guarantee.



DURING THE INITIAL INSTALLATION AND IN CASE OF MAINTENANCE MAKE SURE THAT:

- The power supply has been switched off.
- The power supply is provided with safeguards and in particular a highly sensitive circuit breaker (30 mA in class A) in order to protect from alternating, pulsating unipolar, continuous and high frequency currents due to faults. In addition check that the earthing complies with the required local standards.
- Before removing the lid of the inverter or starting procedures on it the power supply must be disconnected before waiting at least five minutes so that the capacitors have the time to lose their charge through the incorporated discharge resistors.



WARNING: when the DG PED is out of service (red LED flashing) it is still electrically charged. Before any form of intervention on the pump or on the inverter it is obligatory to disconnect the power supply to the pump.



Emergency Stop

- Whilst the DG PED is in operation it is possible to carry out an emergency stop by pressing the I/OON switch.
- In the applications with two units in parallel it is only the MASTER inverter which blocks the system.



During both the first installation and maintenance ensure THERE IS NO POWER in the line.



During both the first installation and maintenance ensure the plant is UNPRESSURED.



DO NOT OPEN THE COVERS OF THE INVERTER except the cover of the connectors.

DESCRIPTION OF THE PRODUCT

DG PED is an automatic pressurisation system with an inverter which integrates: built-in high efficiency self-priming pump, an accumulator tank, pressure and flow rate sensors, a non-return valve.

DG PED is a compact autonomous quiet and high performance pumping system.

A sophisticated electronic control inverter controls the entire system in an intelligent and intuitive manner:

- it maintains the pressure of the installation constant by regulating the velocity of the pump in accordance with the water required;
- it controls the hydraulic and electric operating parameters and protects the pump from abnormalities;
- it can be equipped with an expansion card that makes it possible to work in parallel with other DG PED in the pumping groups and to manage input and output signals;
- it adapts to every type of pressurisation system, including

existing ones. Where the regulations permit it the system is suitable for use with the water supply network. In this case insert a non-return valve upstream;

- it limits the starting and operating currents in order to provide a greater saving of energy.

In the applications in parallel the inverter MASTER and the inverter SLAVE, controlled by the MASTER, stand out.

The MASTER receives the parameter programming details, controls the functional data, and activates and deactivates the SLAVES as necessary.



If the MASTER is switched off, the SLAVES return to being autonomous and continue to work independently.

When it works in a parallel configuration with other inverters, DG PED is able to manage the alternation of the starts in order to harmonise the use of the pumps.

LIST OF PARTS

1. Bipolar general switch I/O
2. Cable hole signals (INPUT/OUTPUT)
3. Control Panel
4. Filling plug
5. Expansion vase plug
6. Vent plug
7. Drain plug
8. Expansion card (OPTIONAL)
9. Fuse 12.5 A (rapid intervention)
10. Connector locking bandwidth
11. Adjustable elbow joint, with OR
12. Discharge outlet
13. Suction port
14. Anti-vibration levelling feet
15. Electricity cable

CONTROL PANEL

16. On/off switch 
17. Green coloured LED indicators that indicate:
 - pump working;
 - working pressure;
 - alarms
18. Green or red LED indicators
19. Switches  and  for changing readings

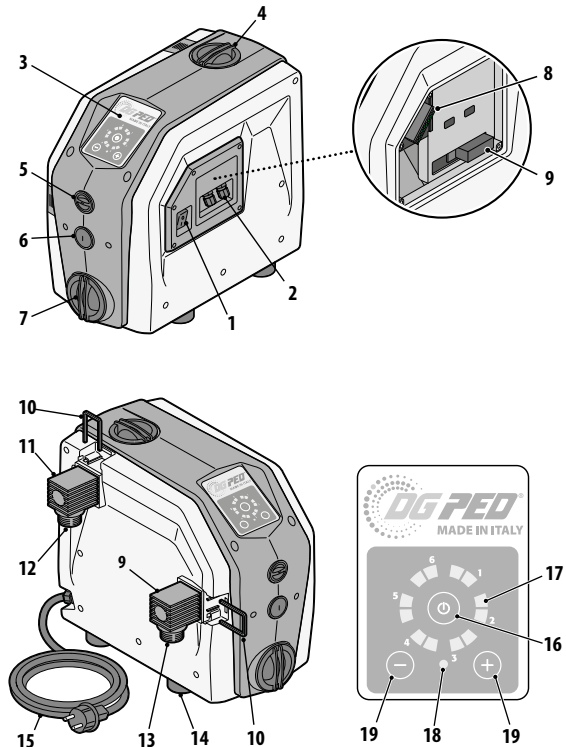

TECHNICAL DATA

- Supply voltage ~ **230 V** ± 10%
- Frequency **50/60 Hz**
- Insulation: **class F**
- Max absorbed current
 - **7.5 A** DG PED 3
 - **10 A** DG PED 5
- P1 Maximum absorbed power:
 - **1.0 kW** DG PED 3
 - **1.5 kW** DG PED 5
- Insulation: class **IP X4**
- Factory set point **3 bar**
- Fuse **12.5 A** (rapid intervention)

APPLICATION LIMITS

- Manometric suction lift up to **8 m**
- Liquid temperature between **0 °C** and **+40 °C**
- Ambient temperature between **0 °C** and **+40 °C**
- Max. working pressure **10 bar**
- Continuous service **S1**
- Vertical position running



CHARACTERISTIC CURVES

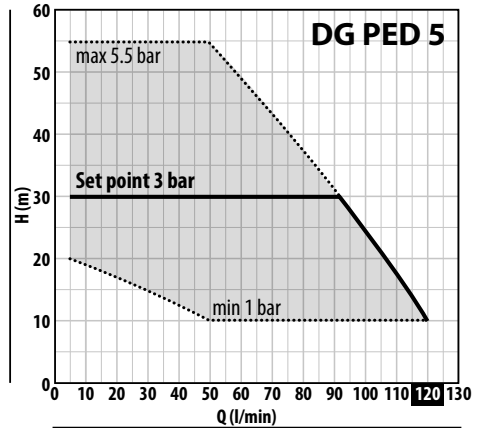
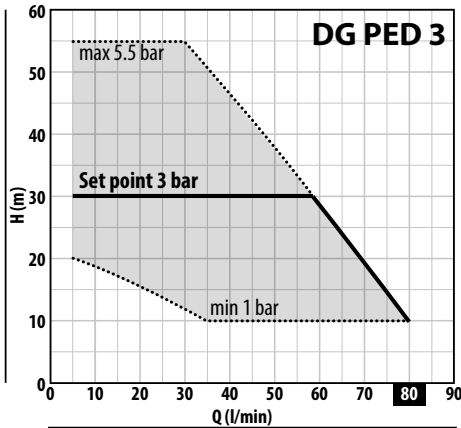

MODEL	POWER		MAX PERFORMANCES	PERFORMANCES (ADJUSTABLE SET POINT)							
	P2			Q		H		Set Point Taratura Std		Max. Set Point	
Single-phase	kW	HP	▲	l/min	metres	Min. Set Point bar	l/min	bar	l/min	bar	l/min
DG PED 3	0.75	1	IE3	5 – 80	55 – 10	1	35 – 80	3	5 – 58	5.5	5 – 30
DG PED 5	1.1	1.5		5 – 120	55 – 10	1	50 – 120	3	5 – 92	5.5	5 – 50

Q = Flow rate H = Total manometric head Tolerance of characteristic curves in compliance with EN ISO 9906 Grado 3B.

▲ Three phase motor efficiency class (IEC 60034-30-1)

The performances shown refer to a head in aspiration equal to -1 m (aspiration of 1 m.). If the water level in aspiration is less than the depth of entrance of the pump the performances will be reduced accordingly.

LUMINOUS SIGNALS

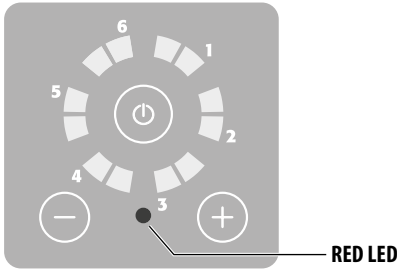

NOT WORKING

DG PED is connected but not working

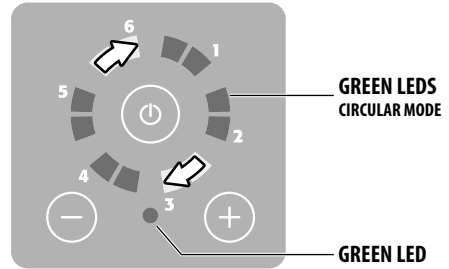

PUMP WORKING

DG PED is connected and the pump is working

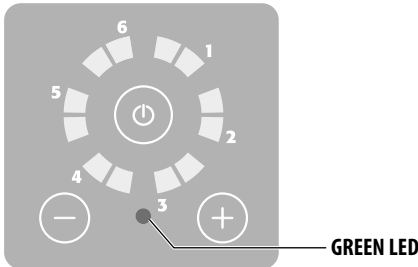

STAND-BY

DG PED is connected but the pump is not working

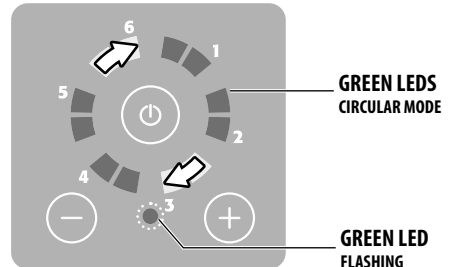

PUMP IN PROCESS OF STOPPING

DG PED is connected and the pump is in process of stopping

INSTALLATION AND HYDRAULIC CONNECTIONS (only for skilled personnel)



During both the first installation and maintenance ensure **THERE IS NO POWER** in the line.



During both the first installation and maintenance ensure the plant is **UNPRESSURED**.

In addition ensure that the electricity supply has protections and in particular has a differential switch of great sensitivity (30 mA in class A) in order to protect from alternating, pulsating unipolar, continuous and high frequency currents due to faults. In addition check that the earthing complies with the required local standards.

Verify that the data on the plate are those desired and that they are adequate for the installation.

Install DG PED in a place:

- protected from external agents;
- ventilated, free of excess humidity or too much dust;
- where it does not suffer from harmful vibrations or mechanical stresses from the tubes connected to it.

- 1 Regulate the levelling feet to correctly level the DG PED.

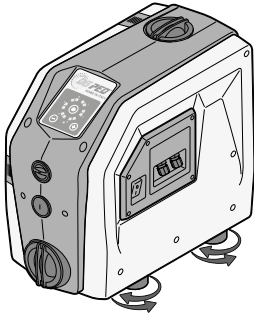

- 2 Remove the covers of the forks.

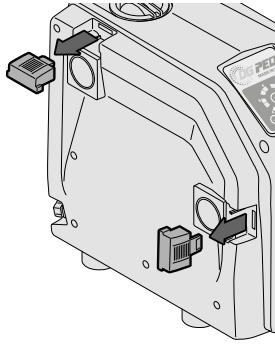

- 3 Remove the forks.

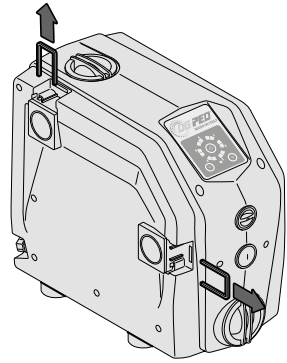

- 4 Insert the elbow fitting complete with O-RING.

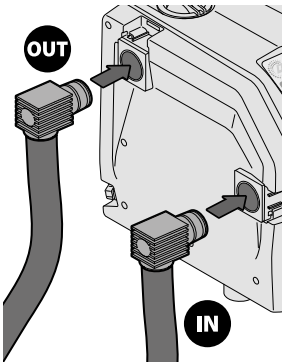

 The aspiration tube must have a minimum diameter of 1" and it must be tightly sealed.

- 5 Correctly insert the forks.

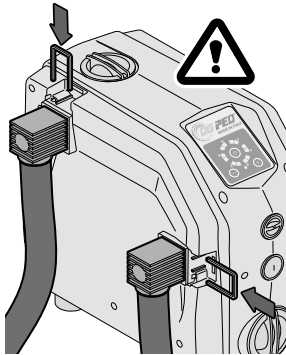

- 6 Insert the fork covers.

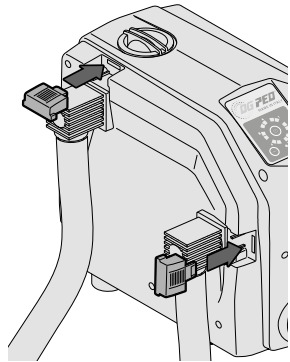

 An expansion vessel can be added to the installation mounted on the delivery side (OUT)

FILLING AND SWITCHING ON (only for skilled personnel)

! Never allow the DG PED to run when dry, to avoid damaging the mechanical seal.

CASE A: functioning WHEN BELOW THE WATER (tank or acqueduct)

1 Open all the valves to fill the pump with water.

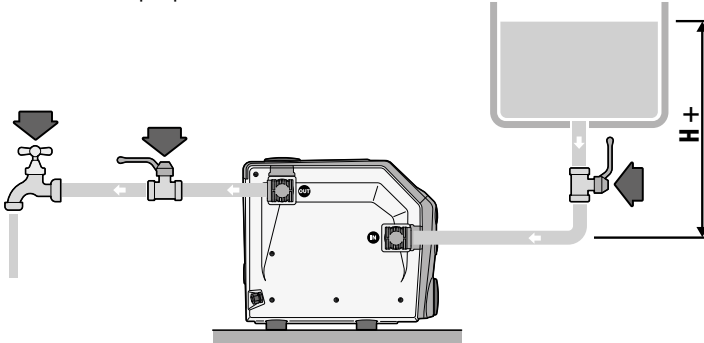

2 Attach the plug to the electricity supply.

3 Turn the switch to "1".

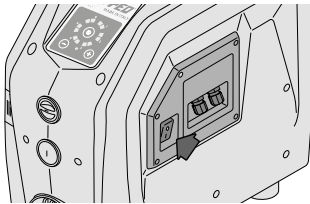

4 Press the  switch to switch on the DG PED.



CASE B: functioning when ABOVE WATER (draught from a tank or well)

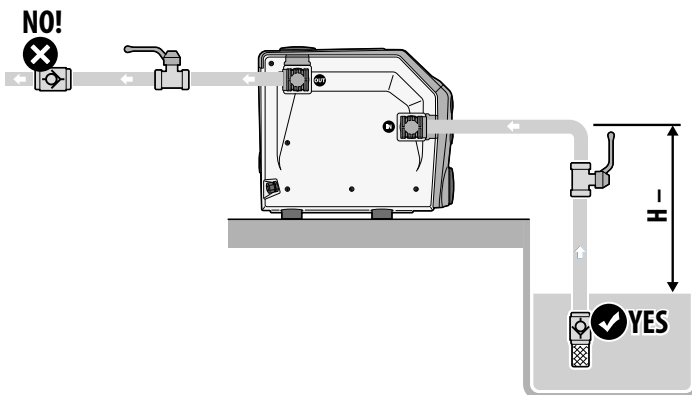

- 1 Unscrew and remove the filling plug and the vent plug.
- 2 Pour in about 1.5 litres of water until it pours out of the vent hole.
- 3 Rescrew the filling plug and the vent plug.
- 4 Open the water tap

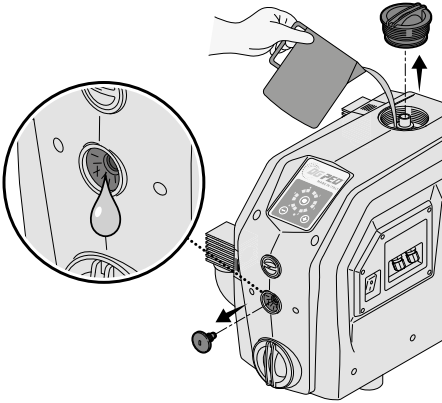

- 5 Attach the plug to the electricity supply.
- 6 Turn the switch to "I".

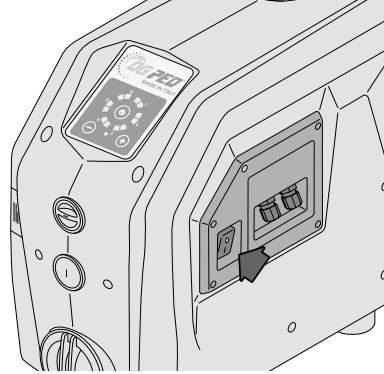

- 7 SIMULTANEOUSLY press buttons ⊕ and ⊖ for 5 seconds. DG PED enters into a priming mode.

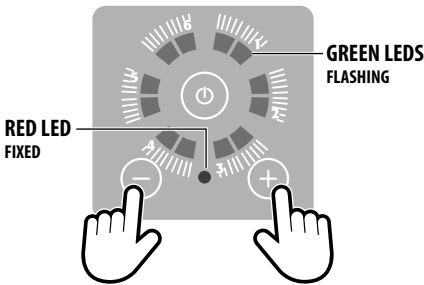

- 8 Press button ⏻ to start priming.

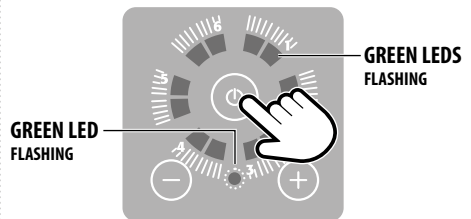

The priming procedure lasts at most 5 minutes, at the end of each minute DG PED automatically stops the electric pump for five seconds then immediately restarts it. This is repeated for all the time the DG PED is priming. During this procedure the LEDES will continue to flash.

The exit from the priming procedure can occur either because of time out (5 minutes) or because it is completed. The LEDES stop flashing. If the pump does not prime repeat the operation from the start.

REGULATION OF THE WORKING PRESSURE

The WORKING PRESSURE is viewed through the green LEDs which are illuminated on the control panel.

The WORKING PRESSURE of the DG PED goes from a minimum of 1 bar to a maximum of 5.5 bar.

To regulate:

- Press button **+** to view the WORKING PRESSURE.
 - Press buttons **+** or **-** to increase or reduce the WORKING PRESSURE.
- Every time button **+** or **-** is pressed the value increases or decreases in steps of 0.5 bar.

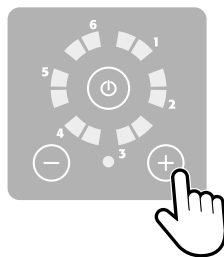

Example

Press button **+** to visualise the WORKING PRESSURE. With the green leds switched on as shown in the diagram the working pressure is **2 bar**.

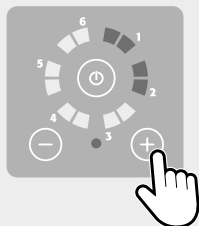

To increase the working pressure to, for example, 3 bar press button **+** twice. The value increases by 1 bar (0.5 + 0.5 bar).

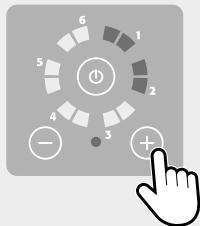

The leds light up as shown in the diagram. Working pressure is **3 bar**.



INFLATION UP OF THE VASE (only for skilled personnel)

The expansion vase inside the DG PED is preloaded in the factory to 1.5 bar.

The optimum inflation of the expansion vessel guarantees the perfect operation of the system and it protects the membrane from premature breakages.

! The inflation of the expansion vessel must be done with an installation pressure of zero. Maximum inflation pressure 4 bar.

! Inflate the expansion vessel as shown in the tablela. For working pressures lower than 3 bar, inflate the vessel by 0.5 bar less than the working pressure.

**Example: working pressure = 2 bar,
inflation pressure = 1.5 bar**

To inflate the expansion vase:

- Remove the plug.
- Use a compressor.
- Attach the tube of the compressor to the correct valve.
- Inflate the expansion vase to the chosen pressure.

! Check the inflation pressure of the vessel at least once a year. If necessary, restore it to the expected value.

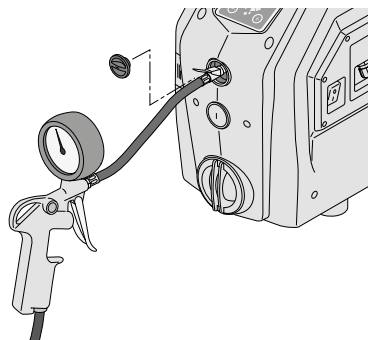

Working pressure	Inflation pressure
3.0 bar	1.5 bar
3.5 bar	2.0 bar
4.0 bar	2.5 bar
4.5 bar	3.0 bar
5.0 bar	3.5 bar
5.5 bar	4.0 bar

SELECTION OF SELF-PRIMING FUNCTION (only for skilled personnel)

The pump leaves the factory as the SELF-PRIMING version; in cases where the negative suction pressure is guaranteed or the feed is already pressurised it is possible to exclude the self-priming function by rotating the lever shown to the vertical position.

- 1 Unscrew and remove the drain plug.
Possible outflow of water.

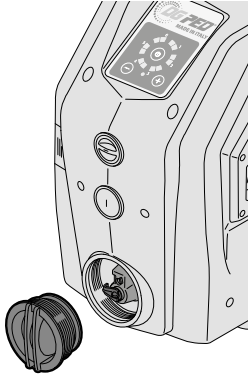

- 2 Rotate the red lever to the vertical position in order to exclude the self-priming function.

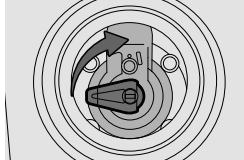

SELF-PRIMING
(factory setting)

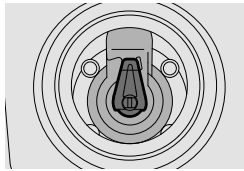

NOT SELF-PRIMING

- 3 Rescrew the drain plug and refill the DG PED with water as described in the FILLING AND SWITCHING ON chapter.



OPTIONAL

ELECTRIC ATTACHMENTS TO THE EXPANSION CARD (only for skilled personnel)



Ensure the electricity supply is SWITCHED OFF.

WARNING: any device connected to the expansion card must be in separated extra-low voltage (SELV).



During removal of the cover do not pull the electric cables connected to the main power switch.

- Unscrew and remove the screws fixing the cover down.
- Partially remove the cover to access the clamps of the expansion card.

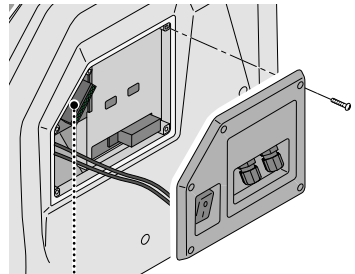

GUIDE TO CLAMPS

1-2	INPUT	INPUT LEVEL SIGNAL-short circuit in absence of a signal
3-4	OUTPUT	ALARM SIGNAL – max 0.3 A @ 230 Va.c. / 1A @ 30 Vd.c.
5-6	RS 485	communication MASTER / SLAVE
7-8	0 V	not connected
9-10	SLAVE	if short circuited the inverter becomes SLAVE

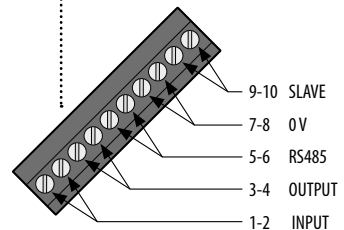

ALARMS

GREEN LED FLASHING + RED LED FLASHING

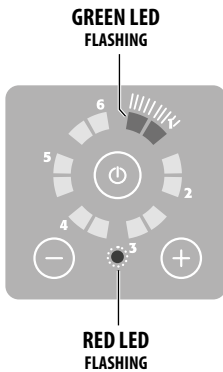

ALARM 1 = Dry running. Set off after 7 sec. of absence of water in suction.

Check the presence of water in aspiration and fill the pump.
 DG PED will effect automatic attempts to restart after 1 min, 15 min, 30 min, 1 h, 1 h, etc.

ALARM 2 = The pump does not reach the set pressure. Contact a repair centre.

ALARM 3 = The pressure of the pre-load of the vase is too low; inflate the vase to 50% of the work pressure (eg. if one works at 3 bar inflate the vase to 1.5 bar).

ALARM 4 = Discharge pressure less than 0.2 bar (broken tube), the reset is only manual. Verify why the pressure has fallen to zero.

ALARM 5 = Supply voltage is too low.
 Guarantee an electric current of 230 v. +/- 10%.

ALARM 6 = External OFF signal.

GREEN LED FIXED + RED LED FLASHING

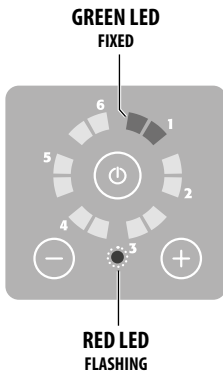

ALARM 1 = Short Circuit. Switch off the device and contact a repair centre.
 Reset is only manual.

ALARM 2 = Too high a current. The current absorbed exceeds the permitted tolerance.
 Reset is only manual. If the problem persists contact a repair centre.

ALARM 3 = Excessive temperature of the module. Check the temperature of the pumped liquid. If the liquid does not have a temperature higher than 40 °C, contact a service center. Automatic reset if the temperature falls below the value of the alarm.

ALARM 4 = Excessive temperature of the motor. If the liquid does not have a temperature greater than 40°C. contact a repair centre. Control the temperature of the pumped liquid.

Automatic reset if the temperature falls below the alarm setting.

ALARM 5 = Invalid signal of the pressure sensor. Contact a repair centre.

ALARM 6 = Invalid signal of the flow sensor. Contact a repair centre.

Example:
 pump in alarm because
 of DRY RUNNING

LED 1 FLASHING
 +
 RED LED FLASHING
 =
 DRY RUNNING

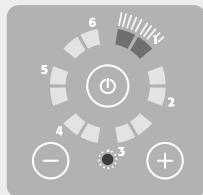

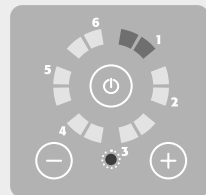

Example:
 Pump in alarm because
 of SHORT CIRCUIT

LED 1 FIXED
 +
 RED LED FLASHING
 =
 SHORT CIRCUIT



TROUBLE SHOOTING

PROBLEM	LED SIGNALS	INTERVENTION
The keyboard does not switch on.	LEDS switched off.	Verify that the lateral switch is in position "I".
		 Verify the electric current switched on, verify the differential switch is suitable.
The pump does not switch on when a consumer seeks to be supplied.	Red LED permanently on.	Switch pump on by pressing the switch "I/O".
	Red LED on and flashing.	See list of alarms in the previous pages.
	Green LED permanently on.	The pressure of the system does not fall below the pressure of the set work.
Alarm of DRY RUNNING.	Red LED flashing Green LEDs in position 1 flashing.	Verify the presence of water in aspiration. Verify the aspiration is not blocked. Fill and prime the pump.
Alarm of SHORT CIRCUIT.	Red LED flashing Green LEDs in position 1 fixed.	 Verify the pump is not blocked by opening the posterior tap of the motor and rotating the shaft.
		 Verify the cable, the plug and the socket are integral and that there are no dispersions.
Alarm of ELECTRIC POWER too low.	Red LED flashing Green LEDs in position 5 flashing.	The voltage is more than 10% inferior to the set value, stabilise the voltage to keep it within the +/-10% limits.
The pump stops and restarts continuously	LED in normal operating condition	Check that the inflation pressure of the vessel is correct. Search for and eliminate leaks in the system.

MAINTENANCE (only for skilled personnel)

INSPECTION AND CLEANING OF THE NON-RETURN VALVE

The NON-RETURN VALVE is positioned inside the suction port.

For removal:

- 1 Remove pressure from the system.
- 2 Remove the cover and fork (A).
- 3 Remove the elbow fitting (B).

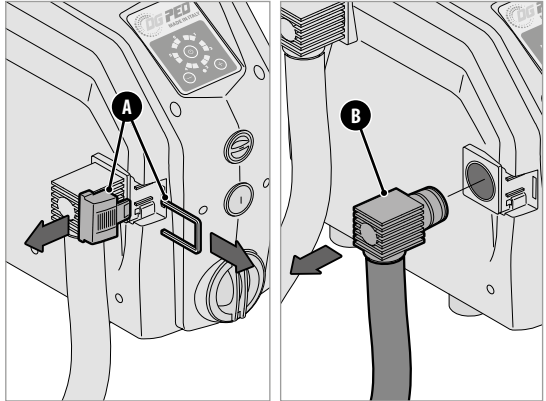

- 4 Extract the NON-RETURN VALVE (C).
- 5 Inspect / clean the NON RETURN VALVE (C).
- 6 Reassemble the NON RETURN VALVE (C) correctly in its seat.
- 7 Reassemble the elbow (B), fork and the cover (A).

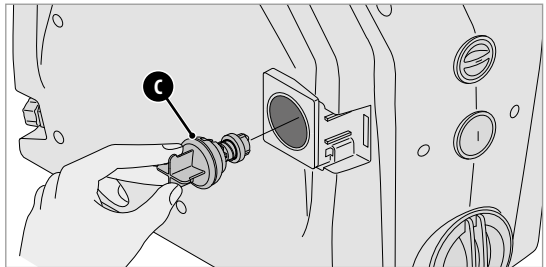

INSPECTION AND CLEANING OF THE FLOW CONTROL VALVE

- 1 **After removing pressure from the system,** unscrew and remove the FILLING PLUG (D).
- 2 Remove the FLOW CONTROL VALVE (E) group by unscrewing the fixing screw. Inspect and clean it.
- 3 Mount the FLOW CONTROL VALVE (E) group. Ensure its orientation is correct!! Re-tighten the retaining screw.
- 4 Correctly screw in the FILLING PLUG (D).

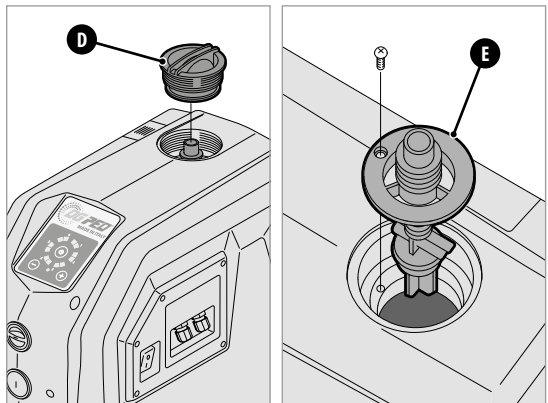

DIMENSIONS (mm)

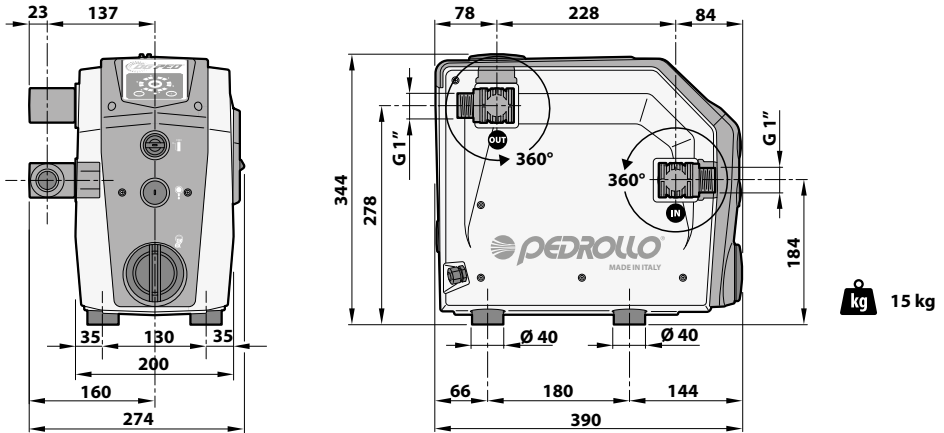

GUARANTEE

Before installing and using the product read all the parts of this manual carefully. The installation and the maintenance must be undertaken by qualified personnel responsible for the hydraulic and electrical attachments in accordance with the applicable current norms.

The manufacturer declines any responsibility for damages caused by an improper use of the product and is not responsible for damages caused by maintenance or repairs carried out by unqualified personnel and/or with non-original spare parts. The use of non-original spare parts, tampering with the product or improper use will result in forfeiture of the guarantee of the product which covers a period of 24 months from the date of purchase.

DISPOSAL

In order to dispose of the parts of which the cards of the DG PED are made you must respect the norms and the laws which are active in the countries where the group is being used.

Do not discard the polluting parts in the environment.



**Correct disposal of WEEE
(DIRECTIVE 2012/19/UE)**

DECLARATION OF CONFORMITY



We hereby declare under our exclusive responsibility, that the product in question results as being in conformity of what is requested by the following European Union Directives, including the latest changes, and by the relevant national laws of implementation:

2006/42/EU, 2014/35/EU, 2014/30/EU, 2009/125/EU, 547/2012/EU, 2011/65/EU, 2015/863/EU, 1907/2006/EU, 2012/19/UE

UK Legislation: 2008 No. 1597, 2016 No. 1101, 2016 No. 1091, 2019 No. 539, 2012 No. 3032

San Bonifacio, 25/02/2022

Pedrollo S.p.A.
Il Presidente
Silvano Pedrollo

ÍNDICE

INFORMACIÓN GENERAL.....	33
NORMAS DE SEGURIDAD.....	33
DESCRIPCIÓN DEL PRODUCTO	34
DATOS TÉCNICOS	35
LIMITES DE UTILIZO	35
CURVAS DE PRESTACIONES	35
SENALES LUMINOSAS	36
INSTALACION Y CONECCIONES HIDRAULICAS.....	36
CEBADO Y ARRANQUE.....	38
REGULACION DE LA PRESION DE TRABAJO	40
INFALDO DEL TANQUE.....	40
SELECCION DEL FUNCIONAMIENTO AUTOCEBANTE	41
CONEXIONES ELECTRICAS DE LA PLACA DE EXPANSION	41
ALARMAS	42
BUSQUEDA DE FALLAS	43
MANTENIMIENTO	44
DIMENSIONES.....	45
GARANTÍA	45
ELIMINACIÓN.....	45
DECLARACIÓN DE CONFORMIDAD	45

INFORMACIÓN GENERAL

Instrucciones originales de uso.

El presente manual siempre deberá acompañar al aparato al que se refiere y guardarse en un lugar accesible y de fácil consulta para las personas encargadas de utilizar y mantener el sistema.

Se recomienda al instalador/usuario que lea atentamente las normas y la información recogida en el presente manual antes de utilizar el producto, a fin de evitar el daño, el uso impropio del aparato o la pérdida de la garantía.

Este producto no deberá ser utilizado por niños ni por personas con capacidades físicas, sensoriales o mentales mermaidas, o con falta de experiencia y conocimiento, en ausencia de supervisión e instrucción. Los niños deberán estar vigilados para asegurarse de que no juegan con el aparato.

La empresa fabricante declina toda responsabilidad en caso de accidente o daños debidos a negligencia o al incumplimiento de las instrucciones descritas en este manual o en condiciones diferentes de las que figuran en la placa. Asimismo, declina toda responsabilidad por daños provocados por un uso inadecuado de la electrobomba.

No superponer pesos u otras cajas al embalaje.

NORMAS DE SEGURIDAD

En el presente manual se utilizan símbolos que tienen el siguiente significado.



Este símbolo avisa de que el incumplimiento de la norma implica un riesgo de descarga eléctrica.



Este símbolo avisa de que el incumplimiento de la norma implica un riesgo de daño material o personal..



ANTES DE INSTALAR Y UTILIZAR EL PRODUCTO:

- Leer atentamente cada una de las partes del presente manual.
- Verificar que los datos de la placacaracterística sean los correctos y adecuados para su instalación.
- La instalación y el mantenimiento deberán correr a cargo de personal cualificado, responsable de realizar las conexiones eléctricas según la normativa de instalación vigente en cada país.

- El fabricante declina toda responsabilidad por daños derivados de un uso inadecuado del producto y no se responsabilizará de daños provocados por mantenimientos o reparaciones realizados por personal no cualificado y/o con piezas de recambio no originales.
- El uso de recambios no originales, manipulados o usos inadecuados, implicarán la pérdida de la garantía del producto.



En la fase de primera instalación y en caso de mantenimiento, asegurarse de que:

- No hay tensión en la red de alimentación eléctrica.
- La red de alimentación eléctrica incorpora protecciones y, en concreto, interruptor diferencial de alta sensibilidad (30 mA en clase A) idoneo a proteger de las corrientes de daño de tipo alternativo, unipolar pulsante, continuo, de alta frecuencia. Verificar además que la puesta a tierra sea conforme a las normativas.
- Antes de retirar la tapa del inversor o iniciar intervenciones en este, es necesario desconectar la instalación de la red eléctrica y esperar al menos 5 minutos hasta que los condensadores hayan tenido tiempo de descargarse mediante los resistores de descarga incorporados.



ATENCIÓN: en estado de fuera de servicio (parpadeo del LED rojo), DG PED permanece en tensión, antes de cualquier intervención en la bomba o en el inversor es obligatorio cortar la tensión desde el grupo.



PARADA DE EMERGENCIA

- Mientras TISSEL-200 está en funcionamiento, es posible realizar una parada de emergencia, pulsando la tecla I/O.
- En las aplicaciones con dos unidades montadas en paralelo es sólo el inverter MASTER el que bloquea el sistema.



En la fase de primera instalación y de mantenimiento, cerciorarse de que NO HAY TENSIÓN en la red eléctrica



En la fase de primera instalación y mantenimiento, cerciorarse de que la instalación NO ESTÁ BAJO PRESIÓN



NUNCA ABRIR LA TAPA DEL INVERTER excepto de la tapa del conector

DESCRIPCIÓN DEL PRODUCTO

DG PED es un sistema de presurización automático con inverter compuesto de una electrobomba autocebante de elevada eficiencia, un tanque de expansión, sensores de caudal y de flujo y una válvula antirretorno.

DG PED es un sistema de bombeo compacto, silencioso y performante.

Un sofisticado control electrónico de inverter controla de forma inteligente y intuitiva el sistema completo:

- mantiene constante la presión de la instalación regulando la velocidad de la bomba en función de la demanda de agua;
- controla los parámetros de funcionamiento hidráulicos y eléctricos y protege la electrobomba de posibles anomalías;
- Puede ser dotado de placa de expansión que permite trabajar con dos equipos en paralelo en los grupos de bombeo y permite manejar señales en entrada y en salida;

- se adapta a todo tipo de instalación de presurización, ya existente. Si la legislación lo permite, el aparato es adecuado para su uso en la red idrónica. En este caso, coloque una válvula de retención aguas arriba;
- limita la corriente de arranque y de funcionamiento para garantizar un mayor ahorro de energía.

En las aplicaciones en paralelo, hay un inverter **MASTER** y un inverter **ESCLAVO**, ambos controlados por el **MASTER**.

El **MASTER** recibe la programación de los parámetros y controla los datos de funcionamiento, activa y desactiva el **ESCLAVO** según la demanda.

Si el **MASTER** se apaga, el **ESCLAVO** vuelve a ser autónomo y continúan a funcionar de forma independiente.

Cuando trabajan en modalidad paralela con otro inverter, **DG PED** maneja la alternanza de los arranques, para uniformar el utilizzo de las bombas.

DESCRIPCION DEL PRODUCTO

1. Interruptor general bipolar I/O
2. Pasacables de las señales INPUT/OUTPUT
3. Panel de control
4. Tapón de cebado
5. Tapón de carga del tanque de expansión
6. Tapón de purga de aire
7. Tapón de descarga
8. Placa de expansión
9. Fusible 12.5 A (con acción rápida)
10. Horquilla de bloqueo del conector
11. Conector de codo orientable, con OR
12. Bocca de impulsión (OUT)
13. Bocca de aspiración (IN)
14. Pies de apoyo antivibración
15. Cable de alimentación

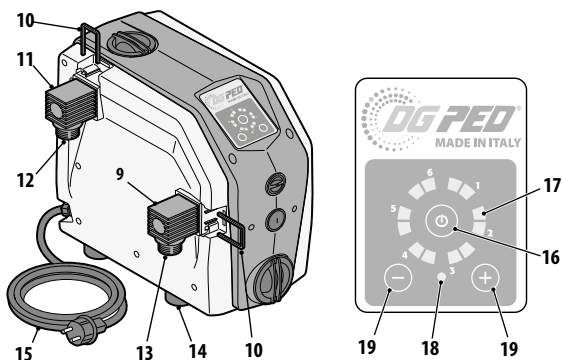
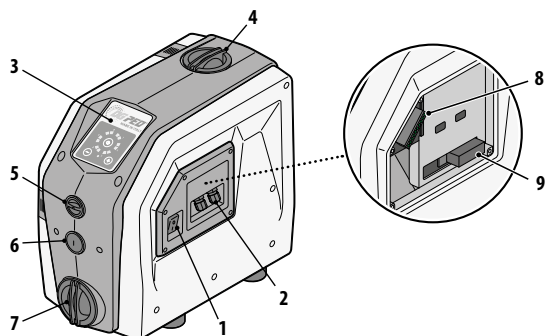

PANEL DE CONTROL

16. Tecla de encendido/apagado
17. Indicador LED de color verde que indica:
 - bomba en marcha;
 - presión de trabajo;
 - alarmas
18. Indicadores LED de color verde y rojo
19. Interruptores \oplus y \ominus para el incremento de los valores

DATOS TÉCNICOS

- Tensión de alimentación ~ **230 V** ± 10%
- Frecuencia **50/60 Hz**
- Isolamento: **clase F**
- Corriente máxima absorbida
 - **7.5 A** DG PED 3
 - **10 A** DG PED 5
- P1 Potencia máxima absorbida:
 - **1.0 kW** DG PED 3
 - **1.5 kW** DG PED 5
- Grado de protección **IP X4**
- Set point de fábrica 3 bares **3 bar**
- Fusible **12.5 A** (con acción rápida)

LIMITES DE UTILIZO

- Altura de aspiración manométrica hasta **8 m**
- Temperatura del líquido de **0 °C** hasta **+40 °C**
- Temperatura ambiente de **0 °C** hasta **+40 °C**
- Presión máxima en el cuerpo de la bomba **10 bar**
- Funcionamiento continuo **S1**
- Posición de trabajo vertical



CURVAS DE PRESTACIONES

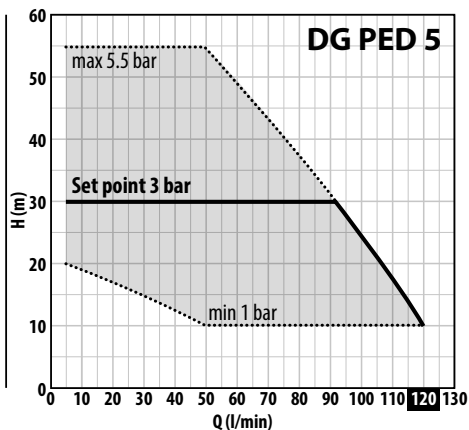
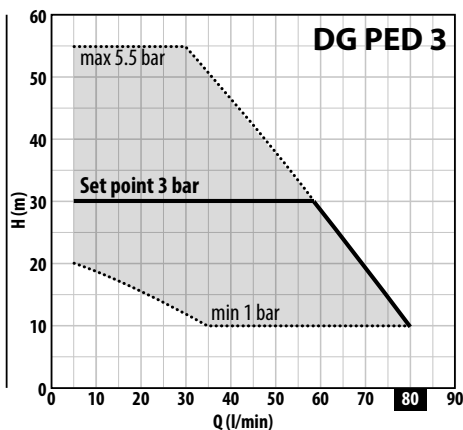

MODELO	POTENCIA			MÁXIMAS PRESTACIONES		PRESTACIONES (SET POINT REGULABLES)					
	P2		▲	Q	H	Set point Min.		Set poin de Tarado Std		Set Point Max.	
Monofásica	kW	HP			l/min	metri	bar	l/min	bar	l/min	bar
DG PED 3	0.75	1	IE3	5 – 80	55 – 10	1	35 – 80	3	5 – 58	5.5	5 – 30
DG PED 5	1.1	1.5		5 – 120	55 – 10	1	50 – 120	3	5 – 92	5.5	5 – 50

Q = Caudal H = Altura manométrica total

Tolerancia de las curvas de prestación según EN ISO 9906 Grado 3B.

▲ Clase de rendimiento del motor trifásico (IEC 60034-30-1)

Las prestaciones indicadas se refieren a una cabeza de aspiración igual a -1 m (1 m de aspiración). Si el nivel de agua en la aspiración es más bajo que la boca de admisión de la bomba, las prestaciones serán inferiores en consecuencia.

SENALES LUMINOSAS

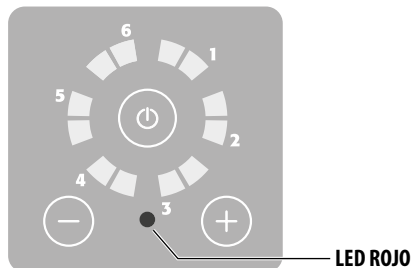

FUERA DE SERVICIO

DG PED en tensión pero fuera de servicio

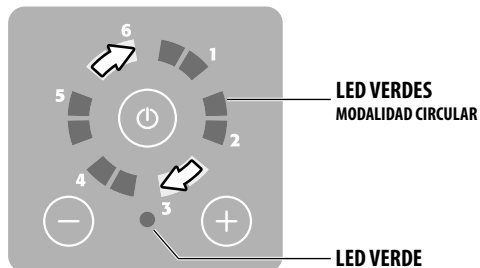

BOMBA EN MARCHA

DG PED en tensión y la bombas está en marcha

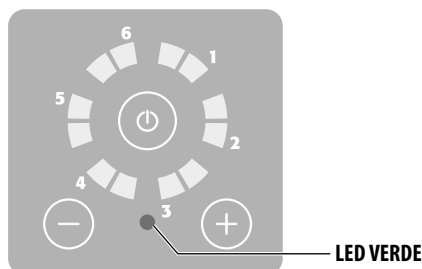

STAND-BY

DG PED está en tensión pero la bomba no está en marcha

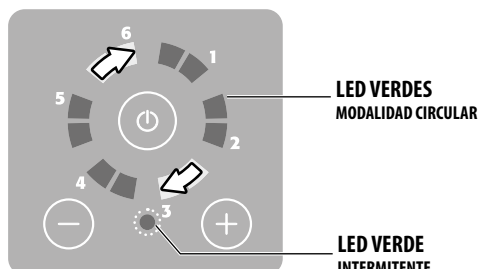

BOMBA EN FASE DE PARADA

DG PED está en tensión y la bomba está en fase de parada

INSTALACION Y CONECCIONES HIDRAULICAS (solo para personal cualificado)



En la fase de primera instalación y de mantenimiento, cerciorarse de que **NO HAY TENSION** en la red eléctrica.



En la fase de primera instalación y mantenimiento, cerciorarse de que la instalación **NO ESTÁ BAJO PRESIÓN**

Además, asegurarse de que la red de alimentación eléctrica incorpora protecciones y, en concreto, interruptor diferencial de alta sensibilidad (30 mA en clase A) idoneo a proteger de las corrientes de daño de tipo alternativo, unipolar pulsante, continuo, de alta frecuencia. Verificar además que la puesta a tierra sea conforme a las normativas. Comprobar que los datos de la placa son los deseados y adecuados a la instalación.

Instalar DG PED en un local:

- protegido de los agentes externos;
- ventilado, sin humedad excesiva ni polvo excesivo;
- de modo que no reciba vibraciones nocivas o esfuerzos mecánicos de las tuberías conectadas.

- 1 Ajustar los pies para nivelar correctamente el DG PED

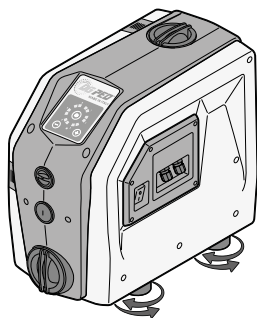

- 2 Remover las tapas de las horquillas

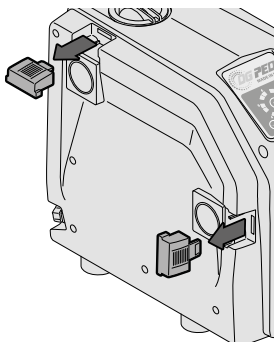

- 3 Remover las horquillas

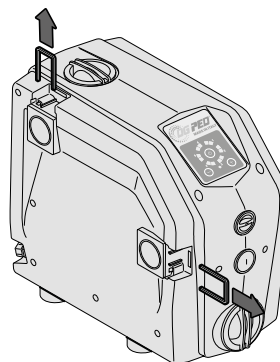

- 4 Colocar los conectores de codo completos con el O-RING

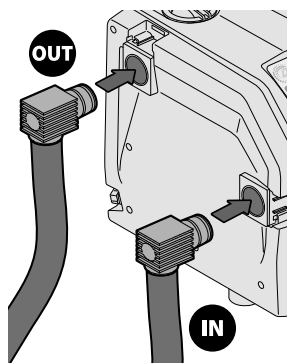

El tubo de aspiración debe tener un diámetro mínimo de 1" y debe ser sellado perfectamente.

- 5 Colocar de forma correcta las horquillas

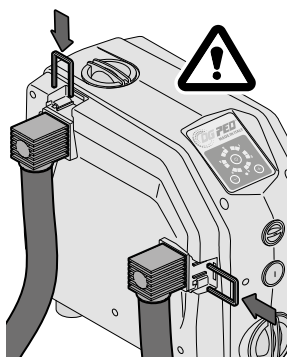

- 6 Colocar las tapas de las horquillas

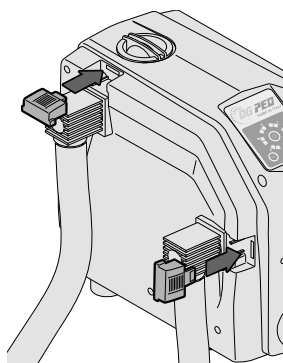

Es posible agregar un tanque de expansión al sistema, instalado en el lado de impulsión (OUT)

CEBADO Y ARRANQUE (solo para personal cualificado)

! Nunca haga funcionar el DG PED en seco, ya que esto puede dañar el sello mecánico.

SITUACION A: funcionamiento con carga positiva (tanque de agua o acueducto)

1 Abrir todas las válvulas para llenar la bomba con agua

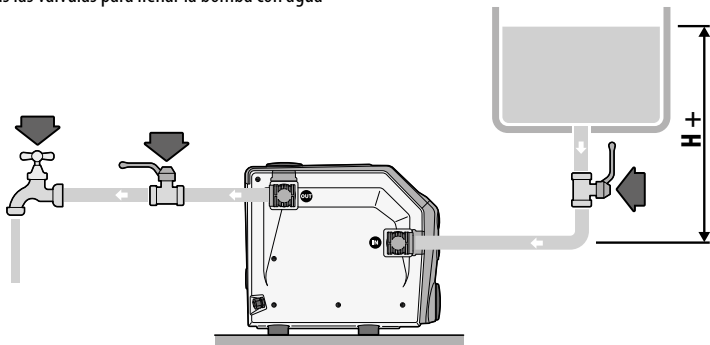

2 Conectar la toma de corriente a la red eléctrica

3 Desplazar el interruptor a la posición "I"

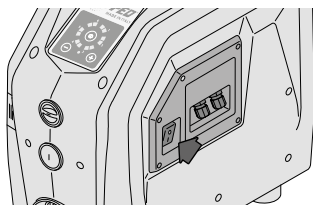

4 Presionar la tecla  para encender el DG PED.



SITUACION B: funcionamiento con carga negativa (aspirando de un tanque enterrado o desde un pozo)

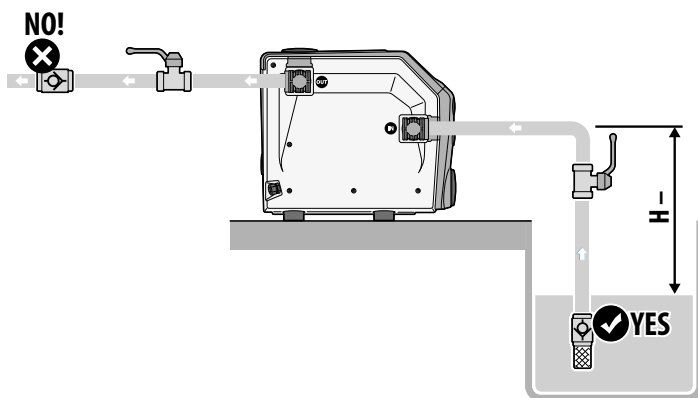

- 1 Remover el tapón de cebado y el tapón de purga.
- 2 Añadir aproximadamente 1.5 litros de agua hasta que empiece a salir por el orificio de purga.
- 3 Colocar el tapon de cebado y el tapón de purga.
- 4 Abrir el grifo de agua.

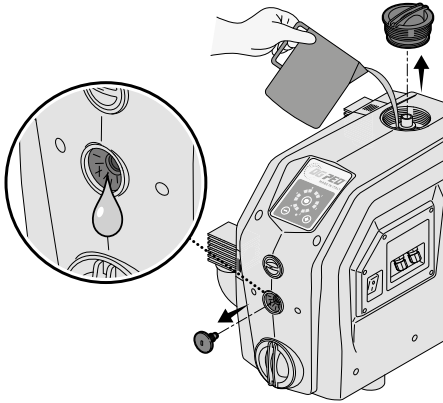

- 5 Conectar la toma de corriente a la red eléctrica.
- 6 Desplazar el interruptor a la posición "I".

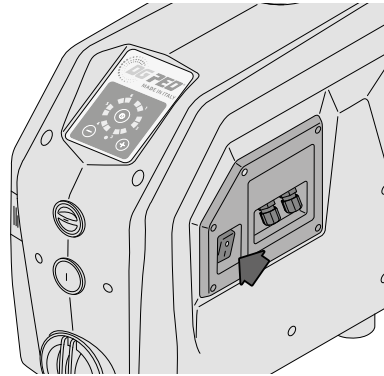

- 7 Presionar CONTEMPORANEAMENTE las teclas ⊕ y ⊖ durante 5 segundos. DG PED entrará en la modalidad autocebante.

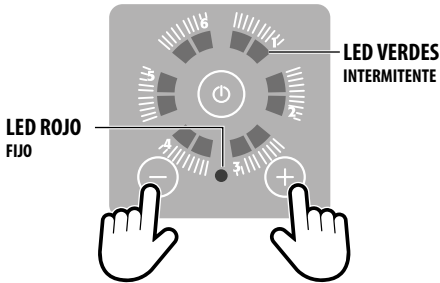

- 8 Presionar la tecla ⏻ para empezar el cebado.

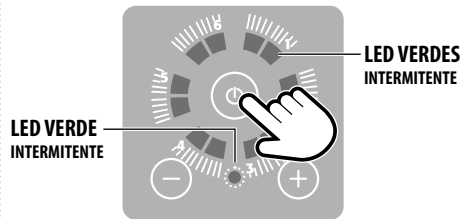

El proceso de cebado dura como mucho 5 minutos, cada minuto DG PED automáticamente detiene la electrobomba durante 5 minutos y la vuelve a encender una vez pasados los mismos. Y así durante todo el tiempo que DG PED permanecerá en la posición de cebado. Durante este proceso los LED continuarán a funcionar de forma intermitente.

La salida del proceso de cebado puede ocurrir o por time out (5 minutos) o porque se completó la fase de cebado. Los led dejarán de trabajar de forma intermitente. Si la electrobomba no se ceba repetir de nuevo el procedimiento desde el inicio.

REGULACION DE LA PRESION DE TRABAJO

La PRESION DE TRABAJO se visualiza a través de los LED de color verde los cuales se iluminan en el panel de control. La PRESION DE TRABAJO del DG PED va de un mínimo de 1 bar a un máximo de 5.5 bar.

Para la regulación:

- Presionar la tecla **+** para visualizar la PRESION DE TRABAJO
- Presionar los interruptores **+** o **-** para aumentar o disminuir la PRESION DE TRABAJO. Cada vez que presionamos la tecla **+** o **-** se incrementará o reducirá el valor a escalones de 0.5 bar.

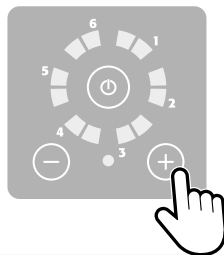

Ejemplo

Presionar la tecla **+** para visualizar la PRESION DE TRABAJO

Con los led verdes encendidos, como se ilustra en la figura, la presión de trabajo es de **2 bar**.

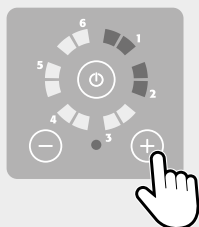

Para llevar la presión de trabajo a, por ejemplo, 3 bar, presionar dos veces el pulsador **+**.

El valor se incrementará de 1 bar (0.5+0.5 bar).

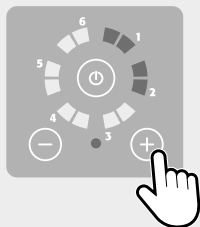

Los leds se encenderán como ilustrado en la figura. Presión de trabajo **3 bar**.



INFALDO DEL TANQUE (solo para personal cualificado)

El tanque de expansión dentro del DGPED viene ya precargado de fábrica a 1.5 bar.

El inflado óptimo del vaso garantiza el perfecto funcionamiento del sistema y protege de la ruptura prematura de la membrana.



El recipiente debe estar inflado con cero presión del sistema. Presión máxima de inflado 4 bar.



Cargue el tanque de expansión como se indica en la tabla. Para presiones de trabajo inferiores a 3 bar, cargue el tanque con 0,5 bar menos que la presión de trabajo.

**Ejemplo: presión de trabajo = 2 bar,
presión de carga = 1.5 bar**

Para inflar el tanque de expansión:

- Remover el tapón
- Disponer de un compresor
- Conectar el tubo del compresor a la válvula de carga
- Inflar el tanque de expansión a la presión deseada



Compruebe la presión de carga del tanque al menos una vez al año. Si es necesario, cargue el tanque al valor previsto.

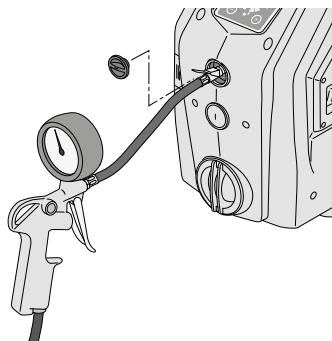

Presión de trabajo	Presión de inflado
3.0 bar	1.5 bar
3.5 bar	2.0 bar
4.0 bar	2.5 bar
4.5 bar	3.0 bar
5.0 bar	3.5 bar
5.5 bar	4.0 bar

SELECCION DEL FUNCIONAMIENTO AUTOCEBANTE (solo para personal cualificado)

La bomba sale de fábrica en la versión AUTOCEBANTE; en el caso de que se garantice el funcionamiento con carga positiva o que la alimentación sea con presión, es posible excluir la función de autoaspiración girando la palanca que se muestra a continuación en posición vertical.

- 1 Desenroscar y sacar el tapón de descarga. Posible salida de agua.

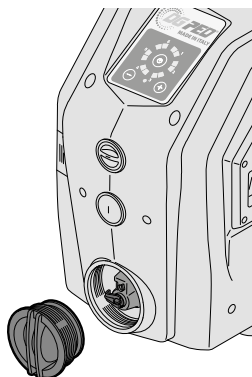

- 2 Rotar la leva roja en posición vertical para excluir el funcionamiento autocebante.

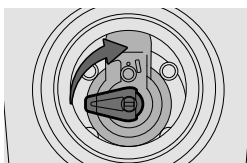

AUTODESCANTE
(settaggio di fabbrica)

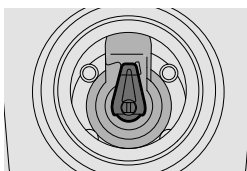

NON AUTODESCANTE

- 3 Volver a colocar el tapón de cebado y rellenar de agua nuevamente el DG PED como indicado en el capítulo LLENADO Y ENCENDIDO.

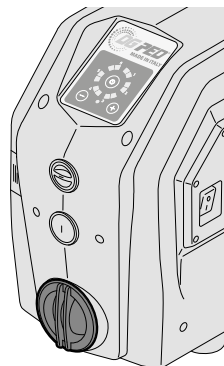

CONEXIONES ELECTRICAS DE LA PLACA DE EXPANSION (solo para personal cualificado)

 Asegurarse que **NO HAYA TENSION** en la red eléctrica.

ADVERTENCIA: cualquier dispositivo conectado a la tarjeta de expansión debe tener un voltaje de seguridad muy bajo (SELV).

 No tire de los cables eléctricos conectados al interruptor principal cuando retire la cubierta.

- Destornille y quite los tornillos de fijación de la tapa.
- Retire parcialmente la cubierta para acceder al tablero de terminales de la tarjeta de expansión.

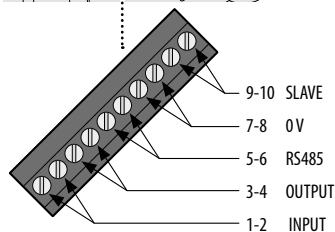
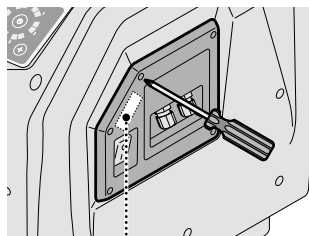

LEYENDA BORNERA

1-2	INPUT	INPUT SEÑAL DE NIVEL. Puentear en ausencia de señal
3-4	OUTPUT	SEÑAL DE ALARMA - max 0,3 A @ 230 Va.c. / 1A @ 30 Vd.c.
5-6	RS 485	comunicación MASTER / SLAVE
7-8	0V	no conectado
9-10	SLAVE	si puenteado, el inverter se convierte en SLAVE

ALARMAS

LED VERDE INTERMITENTE + LED ROJO INTERMITENTE

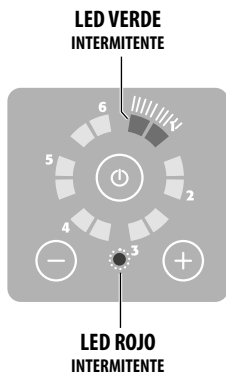

ALARM 1 = Marcia en seco. Interviene después de 7 seg. de ausencia de agua en succión. Controlar la presencia de agua en aspiración y rellenar la bomba. DGPEP realiza intentos automáticos de arranque después de 1 min, 15 min, 30 min, 1h, 1h, etc.

ALARM 2 = La bomba no alcanza la presión programada. Póngase en contacto con un centro de servicio.

ALARM 3 = La presión de pre-carga del tanque es demasiado baja; inflar el tanque al 50% de la presión de trabajo (por ejemplo. Si trabaja a 3 bares, inflar el tanque a 1,5 bar).

ALARM 4 = Presión en la impulsión inferior a 0,2 bar (Tubería rota). El rearme es solo manual. Verificar porqué la presión se fué a cero.

ALARM 5 = Voltaje de alimentación demasiado bajo.
Garantizar 230V +/- 10% en la alimentación.

ALARM 6 = Señal de OFF desde externo.

LED VERDE FIJO + LED ROJO INTERMITENTE

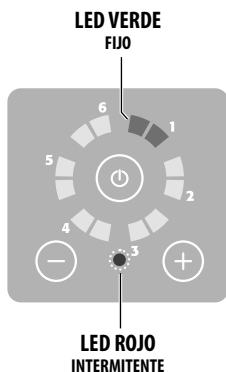

ALARM 1 = Corto circuito. Apagar el dispositivo y contactar un centro de Asistencia. El rearme es solo manual.

ALARM 2 = Sobre corriente. La corriente absorbida excede la tolerancia admitida. El rearme es solo manual. Si el problema persiste, contacte a un centro de servicio.

ALARM 3 = Excesiva temperatura del modulo. Verifique la temperatura del líquido bombeado. Si el líquido no tiene una temperatura superior a 40 °C, comuníquese con un centro de asistencia. Rearme automático si la temperatura desciende por debajo del valor de alarma.

ALARM 4 = Excesiva temperatura del motor. Verificar la temperatura del líquido bombeado. Si el líquido no tiene una temperatura superior a 40 °C, comuníquese con un centro de servicio. Rearme automático si la temperatura desciende por debajo del valor de alarma.

ALARM 5 = Señal del sensor de presión no válido. Contactar un centro de asistencia.

ALARM 6 = Señal del sensor de flujo no válido. Contactar el centro de asistencia.

Ejemplo: Bomba en alarma por MARCHA EN SECO

LED 1 INTERMITENTE
+
LED ROJO INTERMITENTE
=
MARCHA EN SECO

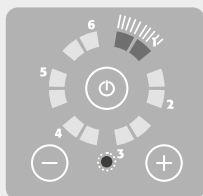

Ejemplo: bomba en alarma por CORTO CIRCUITO

LED 1 FIJO
+
LED TOJO INTERMITENTE
=
CORTO CIRCUITO

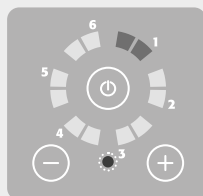

BUSQUEDA DE FALLAS

PROBLEMA	INDICADOR LED	INTERVENCIONES
El teclado no se enciende	LED apagados.	Compruebe que el interruptor lateral está en posición "1".
		 Compruebe la alimentación eléctrica de la red, verifique que el interruptor diferencial sea el adecuado.
La bomba no se enciende a la abertura de un servicio	LED rojo encendido fijo.	Ponga la bomba en servicio presionando la tecla "I/O".
	LED rojo encendido intermitente.	Ver lista de alarmas en las páginas anteriores.
	LED verde encendido fijo.	La presión del sistema no cae por debajo de la presión de trabajo establecida.
Alarma de MARCHA EN SECO	LED rojo intermitente. LED verdes in pos. 1 intermitente.	Comprobar la presencia de agua en la toma. Comprobar que la aspiración no esté obstruida. Llenar y cebar la bomba.
Alarma de CORTO CIRCUITO	LED rojo intermitente. LED verdes en pos. 1 fijos.	 Compruebe que la bomba no esté bloqueada abriendo la tapa trasera del motor y girando el eje.
		 Compruebe que el cable, el enchufe y la toma estén intactos y que no haya fugas
Alarma de BAJA TENSION	LED rojo intermitente, LED verdes en pos. 5 intermitenti.	El voltaje es más bajo que el valor de la placa en más del 10%; Estabilice el voltaje para mantenerlo dentro de los límites +/- 10%
La bomba se detiene y arranca continuamente	LED en condiciones normales de funcionamiento	Compruebe que la presión de carga del tanque sea la correcta. Busque y elimine fugas en la instalación.

MANTENIMIENTO (solo para personal cualificado)

INSPECCIÓN Y LIMPIEZA DE LA VÁLVULA DE RETENCIÓN

La VÁLVULA ANTIRRETORNO está situada en el interior de la boca de aspiración.

Para su mantenimiento:

- 1 Elimine la presión del sistema.
- 2 Remueva la tapa y la horquilla (A).
- 3 Remueva el codo (B).
- 4 Extraiga la VÁLVULA ANTIRRETORNO (C).
- 5 Inspeccione/limpie la VÁLVULA ANTIRRETORNO (C).
- 6 Vuelva a montar correctamente la VÁLVULA ANTIRRETORNO (C) en su asiento.
- 7 Vuelva a montar correctamente el codo (B), la horquilla y la tapa (A).

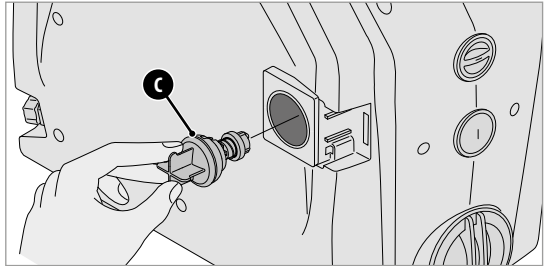
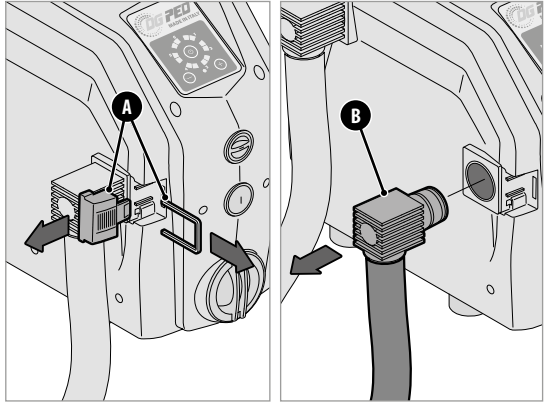

INSPECCIÓN Y LIMPIEZA DE LA VÁLVULA DE FLUJO

- 1 Después de eliminar la presión del sistema, desatornille y quite EL TAPON DE CARGA (D)
- 2 Retire el conjunto de la VÁLVULA DE FLUJO (E) desatornillando el tornillo de fijación. Inspeccionar / limpiarlo
- 3 Monte el grupo de la VÁLVULA DE FLUJO (E). ¡Atención a la orientación! Atornille a apretar el tornillo de fijación
- 4 Atornille correctamente el TAPON DE CARGA (D).

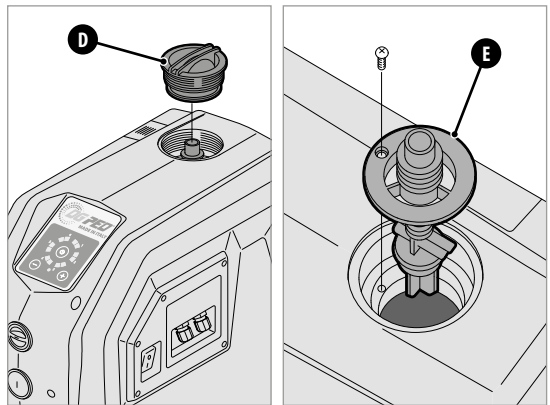

DIMENSIONES (mm)

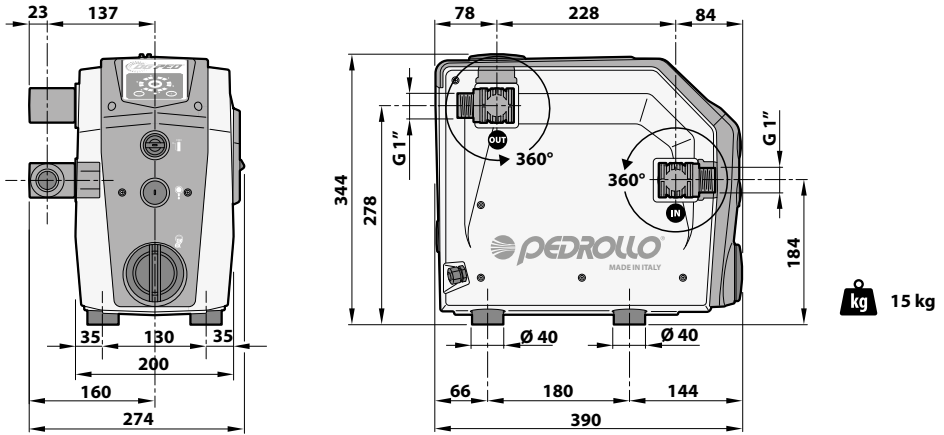

GARANTÍA

Antes de instalar y utilizar el producto leer atentamente todas las partes del presente manual. La instalación y el mantenimiento deberán correr a cargo de personal cualificado, responsable de realizar las conexiones eléctricas según las normas vigentes de aplicación.

El fabricante declina toda responsabilidad por daños derivados de un uso inadecuado del producto y no se responsabilizará de daños provocados por mantenimientos o reparaciones realizados por personal no cualificado y/o con piezas de recambio no originales. El uso de recambios no originales, manipulados o usos inadecuados implicarán la extinción de la garantía del producto que cubre un periodo de 24 meses desde la fecha de compra.

ELIMINACIÓN

Para eliminar las piezas que componen los cuadros TIS-SEL-200, atenerse a las normas y a las leyes vigentes en los países de uso del grupo.

No dispersar partes contaminantes en el medioambiente.



**Correcta eliminación de los RAEE
(DIRECTIVA 2012/19/UE)**

DECLARACIÓN DE CONFORMIDAD



Declaramos, bajo nuestra exclusiva responsabilidad, que el producto en cuestión está conforme con lo previsto por las siguientes Directivas Comunitarias, incluidas las últimas modificaciones, y con la relativa legislación nacional de transposición:

2006/42/EU, 2014/35/EU, 2014/30/EU, 2009/125/EU, 547/2012/EU, 2011/65/EU, 2015/863/EU, 1907/2006/EU, 2012/19/UE

San Bonifacio, 25/02/2022

Pedrollo S.p.A.
El Presidente
Silvano Pedrollo

SOMMAIRE

INFORMATIONS GÉNÉRALES.....	47
RÈGLES DE SÉCURITÉ	47
DESCRIPTION DU PRODUIT.....	48
DONNÉES TECHNIQUES	49
LIMITES D'UTILISATION.....	49
COURBES DE PERFORMANCE.....	49
SIGNALISATIONS LUMINEUSES.....	50
INSTALLATION ET RACCORDEMENTS HYDRAULIQUES	50
REPLISSAGE ET ALLUMAGE	52
RÉGLAGE DE LA PRESSIION DE TRAVAIL.....	54
GONFLAGE DU VASE.....	54
SÉLECTION FONCTIONNEMENT AUTO-AMORÇANT	55
CONNEXIONS ÉLECTRIQUES DE LA CARTE D'EXTENSION.....	55
ALARMES	56
RECHERCHE DES PANNES	57
ENTRETIEN	58
DIMENSIONS	59
GARANTIE.....	59
ÉLIMINATION.....	59
DÉCLARATION DE CONFORMITÉ.....	59

INFORMATIONS GÉNÉRALES

Mode d'emploi original.

Ce manuel doit toujours accompagner l'équipement auquel il se réfère et doit être conservé dans un endroit accessible et consultable par les personnes impliquées dans l'utilisation et la maintenance du système.

Il est recommandé à l'installateur/utilisateur de lire attentivement les instructions et les informations contenues dans ce manuel avant d'utiliser le produit, afin d'éviter tout dommage, utilisation inappropriée de l'équipement ou perte de garantie.

Ce produit ne doit pas être utilisé par des enfants ou des personnes ayant des capacités physiques, sensorielles ou mentales réduites, ou avec un manque d'expérience et de connaissances s'ils n'ont reçu aucune supervision ou instruction. Les enfants doivent être surveillés pour s'assurer qu'ils ne jouent pas avec l'appareil.

Le fabricant décline toute responsabilité en cas d'accident ou de dommage causés par négligence ou non-respect des instructions décrites dans cette brochure ou dans des conditions autres que celles indiquées sur la plaque. Il décline également toute responsabilité pour les dommages causés par une utilisation incorrecte de l'électropompe.

N'empilez pas de poids ou d'autres boîtes sur l'emballage.

RÈGLES DE SÉCURITÉ

Dans ce manuel, les symboles utilisés ont la signification suivante.



Ce symbole signale que le non-respect de la prescription entraîne un risque de choc électrique.



Ce symbole signale que le non-respect des consignes entraîne un risque de dommages aux personnes ou aux biens.



AVANT D'INSTALLER ET D'UTILISER LE PRODUIT :

- lire attentivement ce manuel dans toutes ses parties ;
- vérifiez que les données sur la plaque sont celles souhaitées et appropriées à l'installation ;
- L'installation et l'entretien doivent être effectués par du personnel qualifié, responsable d'effectuer les connexions électriques conformément à la réglementation nationale en matière d'installation ;
- le fabricant décline toute responsabilité pour les dommages résultant d'une utilisation impropre du produit et

n'est pas responsable des dommages résultant de l'entretien ou des réparations effectuées par un personnel non qualifié et/ou avec des pièces de rechange non d'origine ;

- l'utilisation de pièces de rechange non originales, une manipulation ou une utilisation inappropriée annuleront la garantie du produit.



LORS DE LA PREMIÈRE INSTALLATION ET EN CAS D'ENTRETIEN, ASSUREZ-VOUS QUE :

- Il n'y a pas de tension sur le réseau d'alimentation électrique.
- Assurez-vous que le réseau d'alimentation électrique est équipé de protections et notamment d'un disjoncteur différentiel à haute sensibilité (30 mA de classe A) adapté à la protection contre les courants de défaut alternatif, unipolaire pulsatoire, continu, à haute fréquence. Vérifiez également que la mise à la terre est conforme aux normes.
- Avant d'enlever le couvercle de l'onduleur ou de commencer à travailler dessus, il est nécessaire de débrancher le système de l'alimentation et d'attendre au moins 5 minutes afin que les condensateurs se déchargent à travers les résistances de décharge intégrées.



ATTENTION : en état d'hors service (clignotement de la LED rouge), DG PED reste sous tension ; avant d'effectuer toute intervention sur la pompe ou sur l'onduleur, il est impératif de couper la tension du groupe.



ARRÊT D'URGENCE

- Pendant le fonctionnement de DG PED, vous pouvez effectuer un arrêt d'urgence en appuyant sur le bouton I/O.
- Seul l'onduleur MASTER verrouille le système pendant les exécutions avec deux unités en parallèle.



Lors de l'installation et de l'entretien, assurez-vous qu'il N'Y A PAS DE TENSION sur le réseau électrique.



Lors de la première installation et de l'entretien, assurez-vous que le système N'EST PAS SOUS PRESSION.



N'OUVREZ PAS LES COUVERCLES DE L'ONDULEUR, à l'exception du couvercle des connecteurs.

DESCRIPTION DU PRODUIT

DG PED est un système de pressurisation automatique avec onduleur intégrant à l'intérieur : une électropompe auto-amorçante à haut rendement, un grand vase d'accumulation, des capteurs de pression et de débit, un clapet antiretour.

Un véritable système de pompage compact, silencieux et performant.

Un onduleur de contrôle électronique sophistiqué permet de contrôler l'ensemble du système de manière intelligente et intuitive :

- maintient la pression du système constante en ajustant la vitesse de la pompe en fonction de la demande en eau ;
- il contrôle les paramètres de fonctionnement hydrauliques et électriques et protège l'électropompe contre les anomalies ;
- il peut être équipé d'une carte d'extension, qui permet de travailler en parallèle avec d'autres onduleurs dans les groupes de pompage et de gérer des signaux d'entrée et de sortie ;

- il s'adapte à tout type de système de pressurisation, même existant. Lorsque la réglementation le permet, le dispositif est adapté pour une utilisation sur le réseau de distribution d'eau. Dans ce cas, insérez un clapet antiretour en amont ;
- il limite les courants initiaux de démarrage et de fonctionnement pour une économie d'énergie majeure.

Pendant les exécutions en parallèle, on peut identifier un onduleur **MAITRE** et un onduleur **ESCLAVE**, contrôlés par le MAITRE.

Le MAITRE reçoit la programmation des paramètres et contrôle les données de fonctionnement. Il active et désactive les ESCLAVES en fonction des besoins.

Si le MAITRE est éteint, les ESCLAVES seront à nouveau autonomes et continueront à fonctionner indépendamment.

Lorsque vous travaillez en configuration parallèle avec d'autres onduleurs, DG PED gère l'alternance des démarrages, pour uniformiser l'utilisation des pompes.

LISTE DES PIÈCES

1. Interrupteur général bipolaire I/O
2. Passe-câbles signaux d'ENTRÉE/SORTIE
3. Panneau de commande
4. Bouchon de remplissage
5. Bouchon de vase d'expansion
6. Bouchon d'évent
7. Bouchon de vidange
8. Carte d'extension
9. Fusible 12,5 A (pour une intervention rapide)
10. Fourche de blocage du connecteur
11. Raccord courbé orientable, avec OR
12. Bouche de refoulement (OUT)
13. Bouche d'aspiration (IN)
14. Pieds anti-vibration
15. Câble d'alimentation

PANNEAU DE COMMANDE

16. Bouton d'allumage/arrêt
17. Voyants LED verts signalant :
 - pompe en marche ;
 - pression de travail ;
 - alarmes
18. Voyants LED verts ou rouges
19. Touches ⊕ et ⊖ d'augmentation ou diminution des valeurs

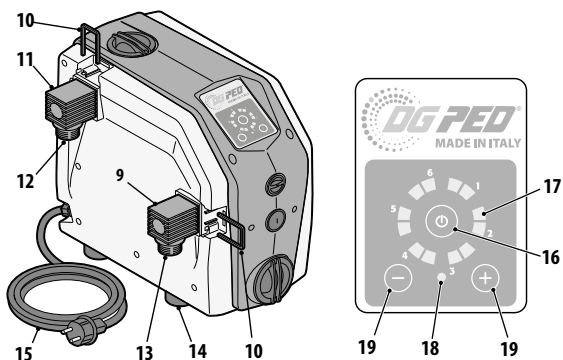
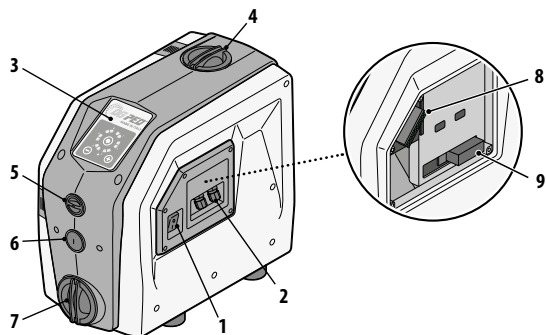

DONNÉES TECHNIQUES

- Tension d'alimentation ~ 230 V ± 10%
- Fréquence 50/60 Hz
- Isolation : classe F
- Courant absorbé maximal
 - 7.5 A DG PED 3
 - 10 A DG PED 5
- P1 Puissance absorbée maximale :
 - 1.0 kW DG PED 3
 - 1.5 kW DG PED 5
- Protection IP X4
- Point de consigne d'usine 3 bars
- Fusible 12,5 A (pour une intervention rapide)

LIMITES D'UTILISATION

- Hauteur manométrique d'aspiration jusqu'à 8 m
- Température du liquide de 0 °C à +40 °C
- Température ambiante de 0 °C à +40 °C
- Pression maximale 10 bar
- Service continu S1
- Position de travail verticale



EAUX CLAIRES



USAGE DOMESTIQUE



USAGE RÉSIDENTIEL

COURBES DE PERFORMANCE

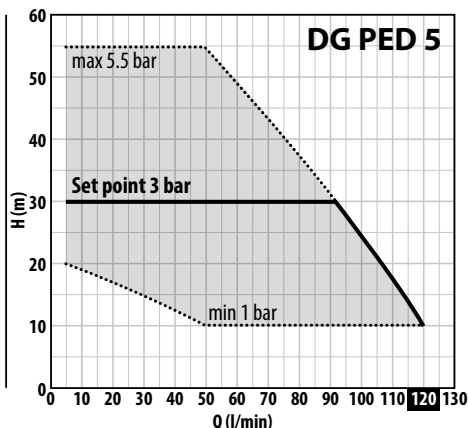
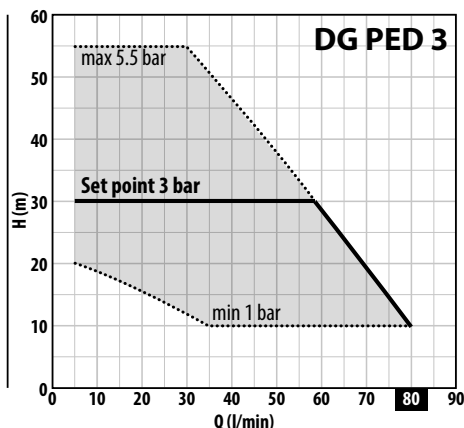

TYPE	PUISSANCE			PERFORMANCES MAX		PERFORMANCES (POINT DE CONSIGNE RÉGLABLE)					
	P2	HP	▲	Q	H	Point de consigne Min.		Set Point Taratura Std		Point de consigne Max.	
Monophasé	kW			l/min	mètres	bar	l/min	bar	l/min	bar	l/min
DG PED 3	0.75	1	IE3	5 – 80	55 – 10	1	35 – 80	3	5 – 58	5.5	5 – 30
DG PED 5	1.1	1.5		5 – 120	55 – 10	1	50 – 120	3	5 – 92	5.5	5 – 50

Q = Débit H = Hauteur manométrique totale

Tolérance des courbes de performance selon EN ISO 9906 Grado 3B.

▲ Classe de rendement du moteur triphasé (IEC 60034-30-1)

Les performances indiquées se rapportent à une hauteur en aspiration égale à -1 m (aspiration d'1 m). Si le niveau d'eau en aspiration est inférieur au niveau d'alimentation de la pompe, les performances seront réduites en conséquence.

SIGNALISATIONS LUMINEUSES

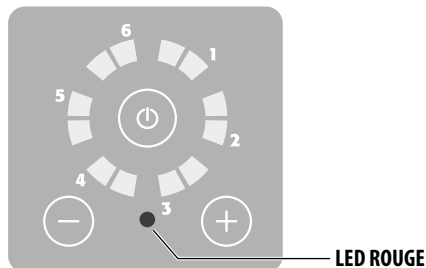

HORS SERVICE

DG PED est sous tension mais hors service.

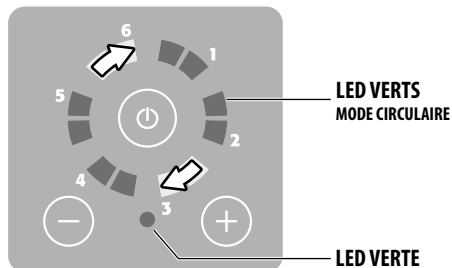

POMPE EN MARCHÉ

DG PED est sous tension et la pompe fonctionne.

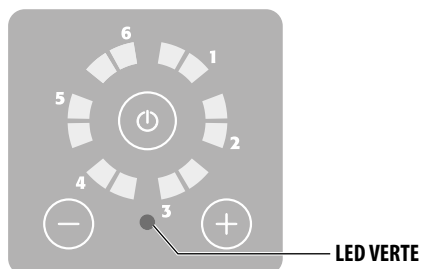

STAND-BY

DG PED est sous tension, mais la pompe ne fonctionne pas.

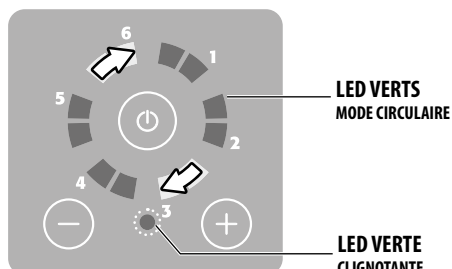

POMPE À L'ARRÊT

DG PED est sous tension et la pompe est à l'arrêt.

INSTALLATION ET RACCORDEMENTS HYDRAULIQUES (réservé au personnel qualifié)



Lors de la première installation et de l'entretien, assurez-vous qu'il **N'Y A PAS DE TENSION** sur le réseau électrique.



Lors de la première installation et de l'entretien, assurez-vous que le système **N'EST PAS SOUS PRESSION**.

Assurez-vous que le réseau d'alimentation électrique est équipé de protections et notamment d'un disjoncteur différentiel à haute sensibilité (30 mA de classe A) adapté à la protection contre les courants de défaut alternatif, unipolaire pulsatoire, continu, à haute fréquence. Vérifiez également que la mise à la terre est conforme aux normes.

Vérifiez que les données sur la plaque sont celles souhaitées et appropriées à l'installation.

Installez DG PED dans un lieu :

- protégé des agents externes ;
- aéré, sans humidité excessive ni poussière excessive ;
- afin qu'il ne reçoive pas de vibrations nuisibles ni de contraintes mécaniques de la part de la tuyauterie raccordée.

- 1 Réglez les pieds pour niveler correctement le DG PED.

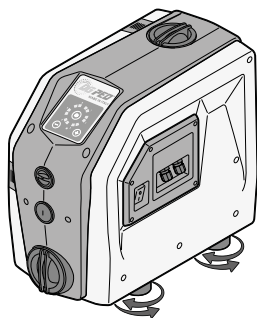

- 2 Retirez les couvercles de fourche.

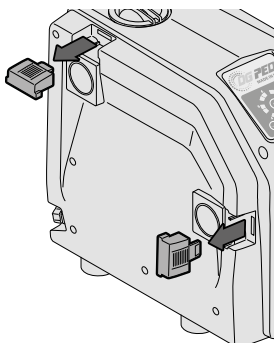

- 3 Retirez les fourches.

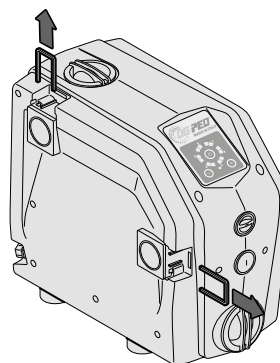

- 4 Insérez les raccords courbés avec O-RING.

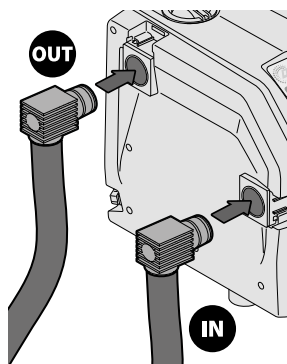

 Le tuyau d'aspiration doit avoir un diamètre de minimum 1" et être parfaitement étanche.

- 5 Insérez les fourches correctement.

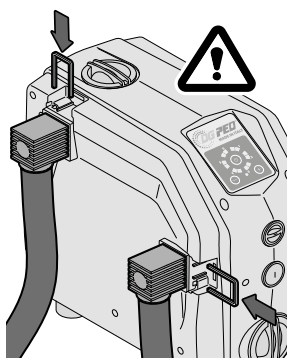

- 6 Insérez les couvercles de fourche.

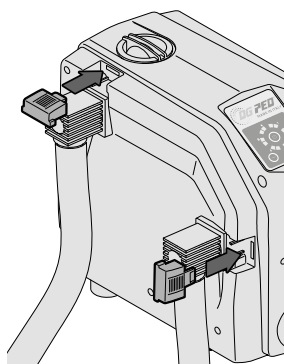

 Vous pouvez ajouter au système un vase d'expansion, installé du côté refoulement (OUT).

REPLISSAGE ET ALLUMAGE (réservé au personnel qualifié)

⚠ Ne jamais faire fonctionner le DG PED à sec, afin d'éviter d'endommager la garniture mécanique.

CAS A : fonctionnement EN CHARGE (réservoir ou aqueduc)

1 Ouvrez toutes les vannes pour remplir d'eau la pompe.

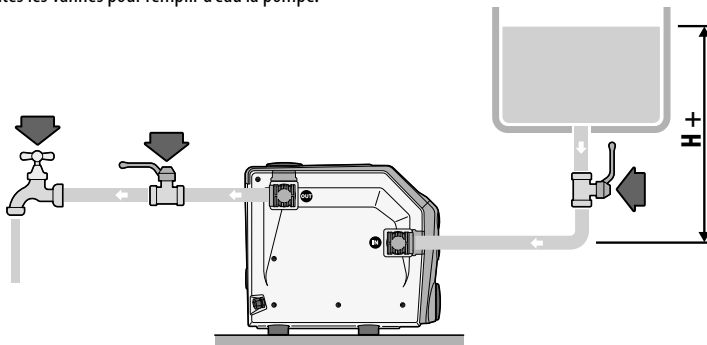

2 Branchez la prise au réseau électrique.

3 Réglez le l'interrupteur sur « I ».

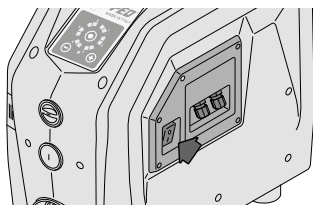

4 Appuyez sur la touche  pour démarrer DG PED.



CAS B : fonctionnement EN ASPIRATION (aspiration du réservoir ou du puits)

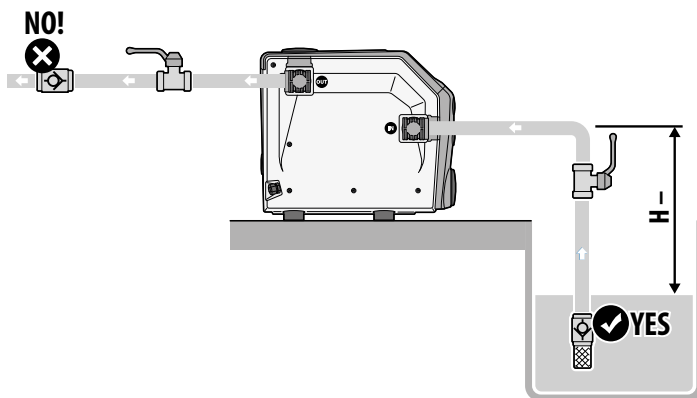

- 1 Dévissez et retirez le bouchon de remplissage et le bouchon d'évent.
- 2 Versez environ 1,5 litres d'eau jusqu'à ce qu'il sorte par l'évent.
- 3 Revissez le bouchon de remplissage et le bouchon d'évent.
- 4 Ouvrir le robinet de l'eau.

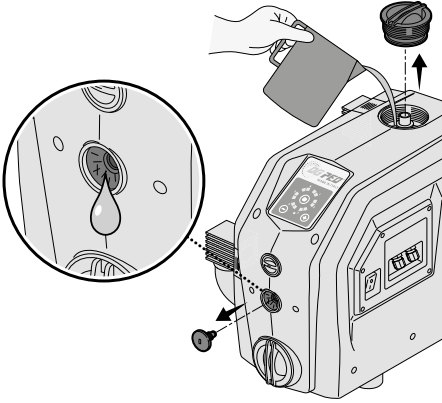

- 5 Branchez la prise au réseaux électrique.
- 6 Réglez l'interrupteur sur « I ».

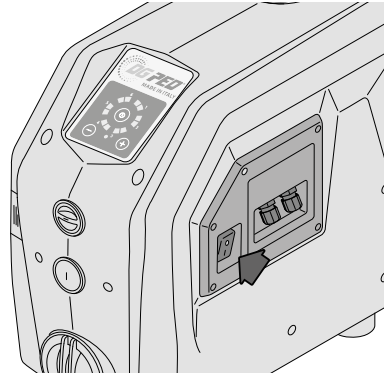

- 7 Appuyez SIMULTANÉMENT sur les touches ⊕ et ⊖ pendant 5 secondes. DG PED entre en mode d'amorçage.

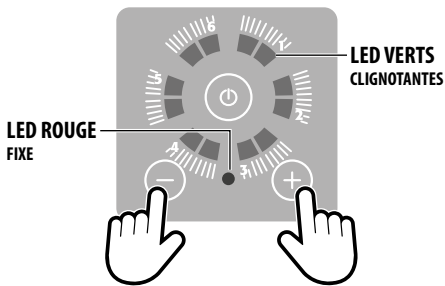

- 8 Appuyez sur la touche ⏻ pour commencer l'amorçage.

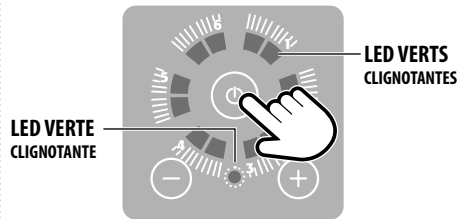

! La procédure d'amorçage dure au maximum 5 minutes. À la fin de chaque minute, DGPED arrête automatiquement l'électropompe pendant 5 secondes et la redémarre lorsqu'elles sont écoulées. Et ainsi de suite tant que DGPED restera en amorçage. Pendant cette procédure, les LED continuent à clignoter.

La sortie de la procédure d'amorçage peut avoir lieu soit par timeout (5 minutes), soit à la fin de la phase d'amorçage. Les LED cesseront de clignoter. Si la pompe ne s'amorce pas, répétez l'opération depuis le début.

RÉGLAGE DE LA PRESSION DE TRAVAIL

La PRESSION DE TRAVAIL est affichée par les LED vertes qui s'allument sur le panneau de commande.

La PRESSION DE TRAVAIL du DG PED va d'un minimum de 1 bar à un maximum de 5,5 bars.

Pour effectuer le réglage :

- Appuyez sur la touche **+** pour afficher la PRESSION DE TRAVAIL.
- Appuyez sur les touches **+** ou **-** pour augmenter ou diminuer la PRESSION DE TRAVAIL. Chaque fois que vous appuyez sur la touche **+** ou **-**, la valeur augmente ou diminue par incréments de 0,5 bars.

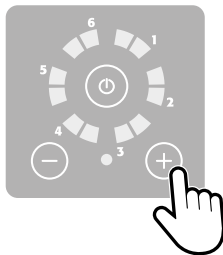

Exemple

Appuyez sur la touche **+** pour afficher la PRESSION DE TRAVAIL.

Lorsque les LED vertes sont allumées comme indiqué sur l'image, la pression de travail est de **2 bars**.

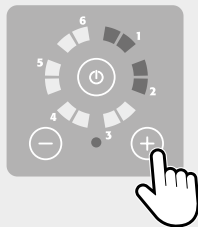

Par exemple, pour régler la pression de travail à 3 bars, appuyez deux fois sur la touche **+**. La valeur est augmentée d'1 bar (0,5 + 0,5 bar).

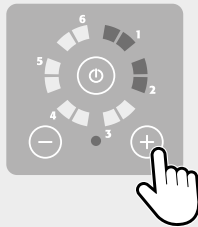

Les LED s'allument comme indiqué sur l'image. Pression de travail **3 bars**.



GONFLAGE DU VASE (réservé au personnel qualifié)

Le vase d'expansion à l'intérieur du DG PED est préchargé en usine à 1,5 bar.

Le gonflage optimal du vase assure le parfait fonctionnement du système et protège contre la rupture prématurée de la membrane.

 **Le gonflage du vase doit être effectué avec une pression de système nulle. Pression maximale de gonflage de 4 bars.**

 **Gonflez le réservoir d'expansion comme indiqué dans le tableau. Pour des pressions de service inférieures à 3 bar, gonfler le réservoir de 0,5 bar de moins que la pression de service. Exemple: pression de service = 2 bar, pression de gonflage = 1.5 bar**

Pour gonfler le vase d'expansion :

- Retirez le bouchon
- Dotez-vous d'un compresseur
- Raccordez le tuyau du compresseur à la vanne de remplissage
- Gonflez le vase d'expansion à la pression désirée

 **Vérifiez la pression de gonflage du réservoir au moins une fois par an. Si nécessaire, remettez-la à la valeur attendue.**

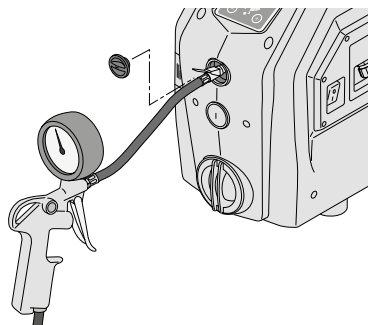

Pression de travail	Pression de gonflage
3.0 bar	1.5 bar
3.5 bar	2.0 bar
4.0 bar	2.5 bar
4.5 bar	3.0 bar
5.0 bar	3.5 bar
5.5 bar	4.0 bar

SÉLECTION FONCTIONNEMENT AUTO-AMORÇANT (réservé au personnel qualifié)

La pompe sort d'usine en version AUTO-AMORÇANTE; dans le cas où le fonctionnement en charge est garanti ou que l'alimentation est déjà sous pression, il est possible d'exclure la fonction d'amorçage automatique en tournant le levier illustré ci-dessous en position verticale.

- 1 Dévissez et retirez le bouchon de vidange. Risque de fuite d'eau.

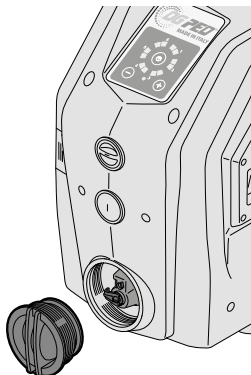

- 2 Tournez le levier rouge en position verticale pour exclure le fonctionnement d'amorçage automatique.

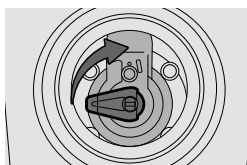

AMORÇAGE AUTOMATIQUE
(réglage d'usine)

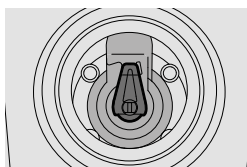

AMORÇAGE NON AUTOMATIQUE

- 3 Revissez le bouchon de vidange. Remplir à nouveau le DG PED avec de l'eau comme indiqué au chapitre REMPLISSAGE ET ALLUMAGE.

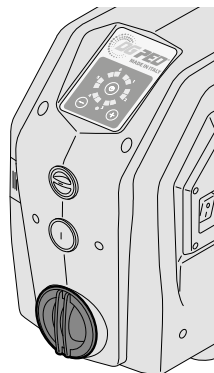

CONNEXIONS ÉLECTRIQUES DE LA CARTE D'EXTENSION (réservé au personnel qualifié)



Assurez-vous qu'il n'y a PAS DE TENSION sur le réseau électrique.

AVERTISSEMENT: tout dispositif connecté à la carte d'extension doit être sous très basse tension de sécurité (SELV).



Ne tirez pas les câbles électriques connectés à l'interrupteur général lorsque vous retirez le couvercle.

- Dévisser et enlever les vis de fixation du couvercle.
- Retirer partiellement le couvercle pour accéder au bornier de la carte d'extension.

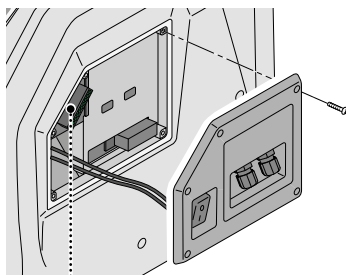

LÉGENDE BORNIER

1-2	ENTRÉE (INPUT)	SIGNAL DE NIVEAU - pointer en l'absence de signal
3-4	SORTIE (OUTPUT)	SIGNAL D'ALARME - max 0,3 A @ 230 Va.c. / 1A @ 30 Vd.c.
5-6	RS 485	communication MAITRE/ESCLAVE
7-8	0 V	non connecté
9-10	SLAVE	si ponté, l'onduleur devient ESCLAVE

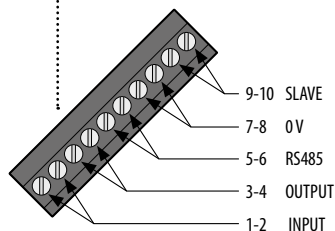

ALARMES

LED VERTE CLIGNOTANTE + LED ROUGE CLIGNOTANTE

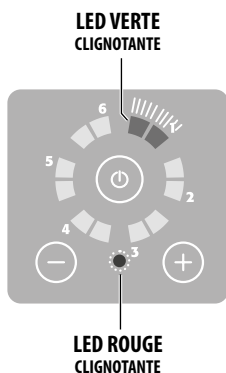

- ALARME 1** = Marche à sec. Il intervient après 7 secondes de l'absence d'eau en aspiration. Vérifiez la présence d'eau à l'aspiration et remplissez la pompe.
DG PED effectue des tentatives de redémarrage automatique après 1 min, 15 min, 30 min, 1 h, 1 h, etc.
- ALARME 2** = La pompe n'atteint pas la pression définie. Contacter un centre d'assistance.
- ALARME 3** = La pression de précharge du vase est trop basse ; gonfler le vase à 50% de la pression de travail (par exemple, si le travail est à 3 bars, gonflez le vase à 1,5 bar).
- ALARME 4** = Pression de refoulement inférieure à 0,2 bar (tuyau cassé). Le réarmement est possible seulement en mode manuel. Vérifier pourquoi la pression a été remise à zéro.
- ALARME 5** = Tension d'alimentation trop basse.
Assurer 230V +/- 10% d'alimentation.
- ALARME 6** = Signal OFF de l'extérieur

LED VERTE FIXE + LED ROUGE CLIGNOTANTE

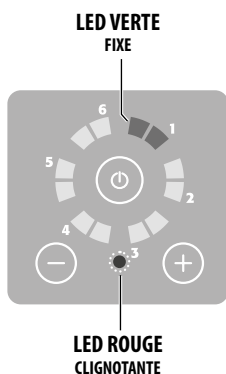

- ALARME 1** = Court-circuit. Éteignez l'appareil et contactez un centre de service. Le réarmement est possible seulement en mode manuel.
- ALARME 2** = Surintensité. Le courant absorbé dépasse la tolérance autorisée. Le réarmement est possible seulement en mode manuel. Si le problème persiste, contacter un centre d'assistance.
- ALARME 3** = Température excessive du module. Vérifiez la température du liquide pompé. Si le liquide n'a pas une température supérieure à 40 °C, contactez un centre de service. Réarmement automatique si la température tombe en dessous de la valeur d'alarme.
- ALARME 4** = Température du moteur excessive. Vérifiez la température du liquide pompé. Si le liquide n'a pas une température supérieure à 40 °C, contactez un centre d'assistance. Réarmement automatique si la température tombe en dessous de la valeur d'alarme.
- ALARME 5** = Signal de capteur de pression invalide. Contactez un centre de service.
- ALARME 6** = Signal de capteur de débit invalide. Contactez un centre de service.

Exemple : Pompe en alarme pour MARCHE À SEC

LED 1 CLIGNOTANTE
+
LED ROUGE CLIGNOTANTE =
MARCHE À SEC

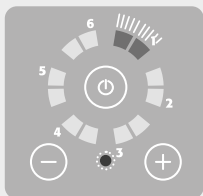

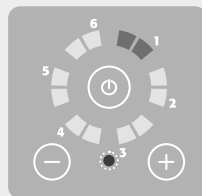

Exemple : pompe en alarme pour COURT-CIRCUIT

LED 1 FIXE
+
LED ROUGE CLIGNOTANTE =
COURT-CIRCUIT



RECHERCHE DES PANNES

PROBLÈME	SIGNAL LED	INTERVENTION
Le clavier ne s'allume pas.	LED éteintes.	Vérifiez que l'interrupteur latéral est en position « I ».
		 Vérifiez la présence de l'alimentation électrique du secteur, vérifiez la conformité du disjoncteur différentiel.
La pompe ne démarre à la création d'une connexion.	LED rouge allumé fixe.	Mettez la pompe en service en appuyant sur la touche « I/O ».
	LED rouge allumée clignotante.	Voir la liste des alarmes aux pages précédentes.
	LED verte allumée fixe.	La pression du système ne tombe pas en dessous de la pression de travail définie.
Alarme de MARCHÉ À SEC.	LED rouge clignotante, LED vertes en pos. 1 clignotantes.	Vérifiez la présence d'eau à l'aspiration. Assurez-vous que l'aspiration ne soit pas obstruée. Remplissez et amorcez la pompe.
Alarme de COURT CIRCUIT.	LED rouge clignotante, LED vertes en pos. 1 fixes.	 Vérifiez que la pompe n'est pas bloquée en ouvrant le bouchon à l'arrière du moteur et en tournant l'arbre.
		 Vérifiez que le câble, la fiche et la prise sont intacts et qu'il n'y a pas de fuites.
Alarme de BASSE TENSION.	LED rouge clignotante, LED vertes en pos. 5 clignotantes.	La tension est inférieure à la valeur de la plaque de plus de 10% ; stabilisez la tension pour la maintenir dans les limites +/- 10%.
La pompe s'arrête et redémarre en continu	LED en état de fonctionnement normal	Vérifiez que la pression de gonflage du réservoir est correcte. Recherchez et éliminez les fuites dans le système.

ENTRETIEN (réservé au personnel qualifié)

INSPECTION ET NETTOYAGE DU CLAPET ANTI-RETOUR

Le CLAPET ANTI-RETOUR est positionné à l'intérieur de l'orifice d'aspiration.

Pour le retrait :

- 1 Enlever la pression du système.
- 2 Retirez le couvercle et la fourche (A).
- 3 Retirez le raccord coudé (B).

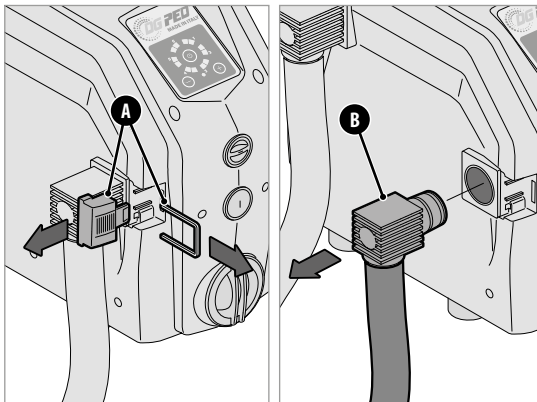

- 4 Extraire le CLAPET ANTI-RETOUR (C).
- 5 Inspectez / nettoyez le CLAPET ANTI-RETOUR (C).
- 6 Remonter correctement le CLAPET ANTI-RETOUR (C) dans son logement.
- 7 Remonter correctement le coude (B), la fourche et le couvercle (A).

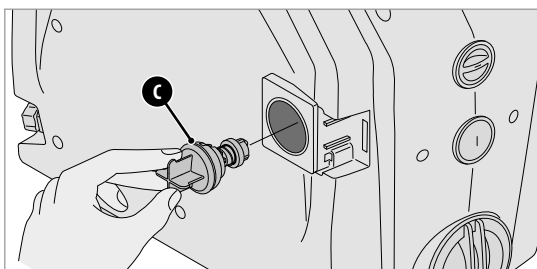

INSPECTION ET NETTOYAGE DE LA SOUPAPE DE DÉBIT

- 1 **Après avoir baissé la pression du système**, dévissez et retirez le BOUCHON DE REMPLISSAGE (D).
- 2 Retirez le groupe SOUPAPE DE DÉBIT (E) en dévissant la vis de fixation. Examinez-le/nettoyez-le
- 3 Installez le groupe SOUPAPE DE DÉBIT (D). Attention à l'orientation ! Visser la vis de fixation.
- 4 Vissez correctement le BOUCHON DE REMPLISSAGE (D).

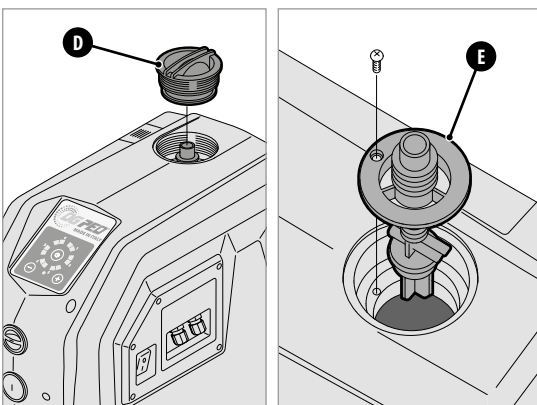

DIMENSIONS (mm)

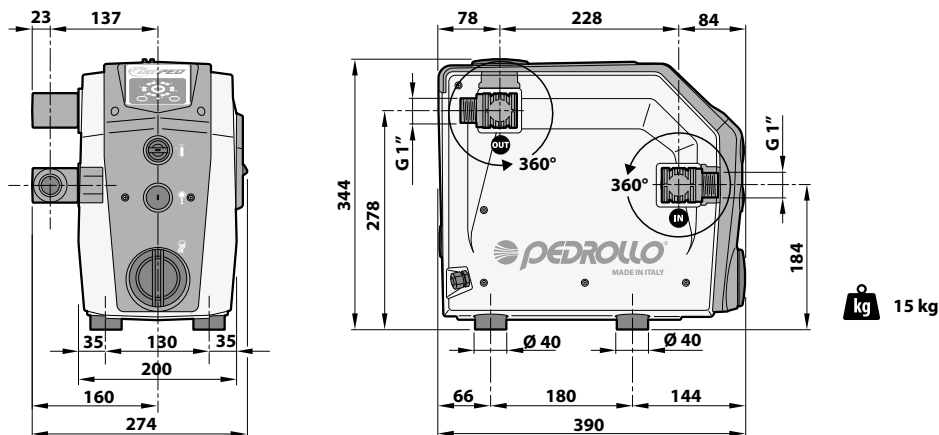

GARANTIE

Avant d'installer et d'utiliser le produit, lisez attentivement ce manuel dans toutes ses parties. L'installation et l'entretien doivent être effectués par du personnel qualifié, responsable d'effectuer les connexions électriques conformément aux normes applicables.

Le fabricant décline toute responsabilité pour les dommages résultant d'une utilisation impropre du produit et n'est pas responsable des dommages résultant de l'entretien ou des réparations effectuées par un personnel non qualifié et/ou avec des pièces de rechange non d'origine. L'utilisation de pièces de rechange non originales, une manipulation ou une utilisation inappropriée annuleront la garantie du produit qui couvre une période de 24 mois à compter de la date d'achat.

ÉLIMINATION

Respectez les règles et les lois en vigueur dans les pays où le groupe est utilisé pour l'élimination des pièces qui composent les panneaux DG PED.

Ne pas jeter de pièces polluantes dans la nature.



Les bons gestes de l'élimination des DEEE (DIRECTIVE 2012/19/UE)

DÉCLARATION DE CONFORMITÉ



Nous déclarons, sous notre seule responsabilité, que le produit en question est conforme aux dispositions des directives communautaires suivantes, y compris les dernières modifications, et à la législation nationale de transposition correspondante :

2006/42/EU, 2014/35/EU, 2014/30/EU, 2009/125/EU, 547/2012/EU, 2011/65/EU, 2015/863/EU, 1907/2006/EU, 2012/19/UE

San Bonifacio, 25/02/2022

Pedrollo S.p.A.

Il Presidente

Silvano Pedrollo

INHALT

ALLGEMEINE INFORMATIONEN.....	61
SICHERHEITSVORSCHRIFTEN	61
BESCHREIBUNG DES GERÄTS	62
TECHNISCHE DATEN	63
BETRIEBSGRENZEN	63
LEISTUNGSKURVEN	63
LEUCHTANZEIGEN	64
INSTALLATION UND HYDRAULIKANSCHLÜSSE	64
AUFFÜLLEN UND EINSCHALTEN.....	66
EINSTELLUNG DES BETRIEBSDRUCKS	68
AUFPUMPEN DES AUSDEHNUNGSGEFÄSSES.....	68
WAHL DES BETRIEBS MIT AUTOMATISCHER ANSAUGUNG.....	69
ELEKTRISCHE ANSCHLÜSSE DER AUSDEHNUNGSKARTE.....	69
ALARME	70
STÖRUNGSSUCHE	71
WARTUNG	72
ABMESSUNGEN	73
GARANTIE.....	73
ENTSORGUNG	73
KONFORMITÄTSEKKLÄRUNG	73

ALLGEMEINE INFORMATIONEN

Originalbedienungsanleitung.

Das vorliegende Handbuch muss das Gerät, auf das es sich bezieht, stets begleiten und an einem gut zugänglichen und geeigneten Ort aufbewahrt werden, damit das für den Gebrauch und die Wartung des Systems zuständige Personal darin nachschlagen kann.

Der Installateur/der Benutzer müssen die in diesem Handbuch enthaltenen Vorschriften und Informationen aufmerksam lesen, bevor sie das Gerät benutzen, um Beschädigungen, einen zweckfremden Gebrauch des Geräts oder den Verlust der Garantie zu vermeiden.

Dieses Gerät darf nicht von Kindern oder Personen mit eingeschränkten körperlichen, sensorischen oder geistigen Fähigkeiten oder Personen ohne Erfahrung und Kenntnisse verwendet werden, wenn keine Schulung erfolgt ist und keine Beaufsichtigung stattfindet. Kinder müssen beaufsichtigt werden, um sicherzustellen, dass sie nicht mit dem Gerät spielen.

Der Hersteller lehnt jede Haftung für Unfälle und Schäden ab, die wegen Fehlverhalten oder mangelnder Einhaltung der in dieser Broschüre angegebenen Anweisungen oder wegen Gebrauchsbedingungen eintreten, die nicht den auf dem Typenschild angegebenen entsprechen. Der Hersteller lehnt auch jede Haftung ab für Schäden, die durch nicht zweckmäßigen Gebrauch der Elektropumpe entstehen. Keine schweren Gegenstände oder andere Schachteln auf der Verpackung ablegen.

SICHERHEITSVORSCHRIFTEN

Im vorliegenden Handbuch werden Symbole verwendet, die folgende Bedeutung haben.



Dieses Symbol weist darauf hin, dass bei Nichtbeachten der Vorschrift Stromschlaggefahr besteht.



Dieses Symbol weist darauf hin, dass bei Nichtbeachten der Vorschrift das Risiko von Personen- und Sachschäden besteht.



VOR DER INSTALLATION UND DEM GEBRAUCH DES GERÄTS:

- Das gesamte vorliegende Handbuch aufmerksam durchlesen.
- Überprüfen, dass die Daten auf dem Typenschild die gewünschten und für die Anlage geeigneten sind.
- Die Installation und Wartung muss von qualifiziertem Fachpersonal vorgenommen werden, das dafür verantwortlich ist, dass die Elektroanschlüsse den nationalen

Vorschriften für die Installation entsprechend ausgeführt werden;

- Der Hersteller lehnt jede Haftung ab für Schäden, die durch nicht zweckmäßigen Gebrauch des Geräts entstehen, und er ist nicht haftbar für Schäden, die durch Wartungs- oder Reparatureingriffe auftreten, die von nicht qualifiziertem Personal und/oder mit nicht originalen Ersatzteilen ausgeführt werden.
- Der Gebrauch von nicht originalen Ersatzteilen, Manipulationen oder nicht zweckmäßige Verwendung führen zum Verfall der Garantie für das Gerät.



IN DER PHASE DER ERSTINSTALLATION UND BEI DER WARTUNG FOLGENDES SICHERSTELLEN:

- An der Stromversorgungsleitung darf keine Spannung anliegen.
- Die Stromversorgungsleitung muss mit einer Schutzvorrichtung ausgerüstet sein, und zwar mit einem hochsensiblen Differentialschalter (30 mA der Klasse A) zum Schutz gegen wechselnde, einpolige, pulsierende, kontinuierliche, hochfrequente Fehlerströme. Außerdem muss überprüft werden, ob die Erdung vorschriftsmäßig ausgeführt wurde.
- Bevor der Deckel des Geräts DG PED entfernt wird, oder bevor mit Eingriffen am Gerät begonnen wird, muss die Anlage vom Stromnetz getrennt werden, und es müssen mindestens fünf Minuten abgewartet werden, damit die Kondensatoren die notwendige Zeit haben, um sich mittels der eingebauten Entladewiderstände zu entladen.



ACHTUNG: Im Status außer Betrieb (rote LED eingeschaltet) bleibt das Gerät DG PED unter Spannung; es ist Pflicht, vor jedem Eingriff die Spannung von der Einheit zu trennen.



NOTHALT

- Während das Gerät DG PED läuft, kann ein Nothalt vorgenommen werden, indem auf die Taste I/O gedrückt wird.
- Bei Anwendungen mit zwei parallel geschalteten Einheiten ist es allein der MASTER-Inverter, der die Anlage blockiert.



In der Phase der Erstinstallation sicherstellen, dass KEINE SPANNUNG am Stromnetz anliegt.



In der Phase der Erstinstallation und Wartung sicherstellen, dass die Anlage NICHT MIT DRUCK BEAUFSCHLAGT IST.



DIE DECKEL DES INVERTERS NICHT ÖFFNEN, ausgenommen den Deckel der Verbinder.

BESCHREIBUNG DES GERÄTS

DG PED ist ein System für die automatische Druckbeaufschlagung mit Inverter, in dessen Innenbereich Folgendes eingebaut ist: eine automatisch ansaugende Hochleistungselektropumpe, ein großer Sammelbehälter, Druck- und Durchflusssensoren, ein Rückschlagventil.

Eine richtige, kompakte, geräuscharme und leistungsstarke Pumpanlage.

Ein hochentwickeltes elektronisches Steuergerät mit Inverter steuert das gesamte System intelligent und intuitiv:

- Beibehaltung des Anlagendrucks, indem die Drehzahl der Pumpe je nach den Wasseranforderungen eingestellt wird.
- Überwachung der die Hydraulik und die Elektrik betreffenden Betriebsparameter und Schutz der Elektropumpe gegen Störungen.
- Das Steuergerät kann mit einer Erweiterungskarte ausgestattet werden, sodass mit weiteren Invertern in den Pumpeinheiten parallel gearbeitet werden kann und Ein- und Ausgangssignale verwaltet werden können.
- Es ist an jede Druckbeaufschlagungsanlage anpassbar,

auch an bereits vorhandene Anlagen. Soweit gesetzlich zulässig, ist das Gerät für den Einsatz am Wasserversorgungsnetz geeignet. In diesem Fall muss vorgeschaltet ein Rückschlagventil montiert werden.

- Einschalt- und Betriebsströme werden begrenzt, um mehr Energie einzusparen.

Bei parallel geschalteten Anwendungen gibt es einen **MASTER**-Inverter und einen **SLAVE**-Inverter, der wiederum vom MASTER gesteuert wird.

Der MASTER empfängt die Programmierung der Parameter und überwacht die Betriebsdaten und aktiviert und deaktiviert die SLAVE-Geräte je nach Bedarf.

Wenn der MASTER ausgeschaltet wird, werden die SLAVE-Geräte wieder eigenständig und laufen unabhängig weiter.

Wenn DG PED in der Konfiguration mit Parallelschaltung mit weiteren Invertern arbeitet, verwaltet DG PED die abwechselnden Einschaltungen, um den Gebrauch der Pumpen einheitlich zu gestalten.

LISTE DER BESTANDTEILE

1. Bipolarer Hauptschalter I/O
2. Kabeldurchführungen Signale INPUT/OUTPUT
3. Bedientafel
4. Verschluss zum Auffüllen
5. Verschluss des Expansionsgefäßes
6. Entlüftungsstopfen
7. Verschluss zum Entleeren
8. Erweiterungskarte
9. Sicherung 12.5 A (mit Schnellauslösung)
10. Gabel für die Befestigung der Verbinder
11. Schwenkbarer Krümmer mit O-Ring
12. Vorlauföffnung (OUT)
13. Ansaugöffnung (IN)
14. Schwingungsdämpfende Standfüße
15. Versorgungskabel

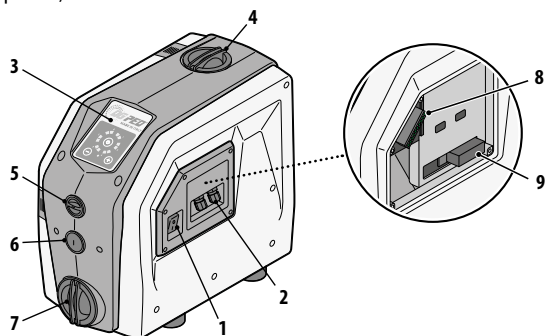

BEDIENTAFEL

16. Taste zum Einschalten / Ausschalten
17. Grüne LED-Anzeigen, die Folgendes melden:
 - Pumpe in Betrieb;
 - Betriebsdruck;
 - Alarme
18. Rote oder grüne LED-Anzeigen
19. Tasten und zum Erhöhen/Vermindern der Werte

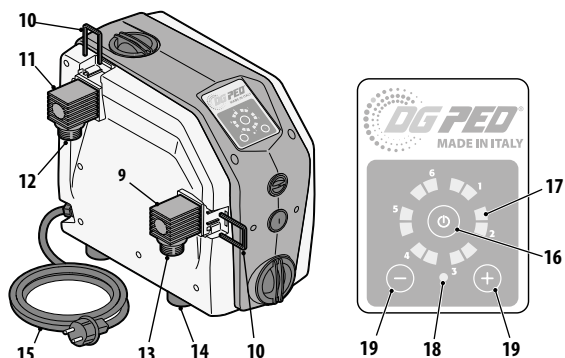

TECHNISCHE DATEN

- Versorgungsspannung ~ **230 V** ± 10%
- Frequenz **50/60 Hz**
- Isolierung: Klasse **F**
- Maximale Stromaufnahme
 - **7.5 A** DG PED 3
 - **10 A** DG PED 5
- P1 Maximale Leistungsaufnahme:
 - **1.0 kW** DG PED 3
 - **1.5 kW** DG PED 5
- Schutzgrad **IP X4**
- Set Werkseitig eingestellter Sollwert **3 bar**
- Sicherung **12.5 A** (mit Schnellauslösung)

BETRIEBSGRENZEN

- Ansaughöhe bis zu 8 m
- Temperatur der Flüssigkeit von **0 °C** bis **+40 °C**
- Umgebungstemperatur von **0 °C** bis **+40 °C**
- Max. Druck **10 bar**
- Dauerbetrieb **S1**
- Vertikale Betriebsposition



LEISTUNGSKURVEN

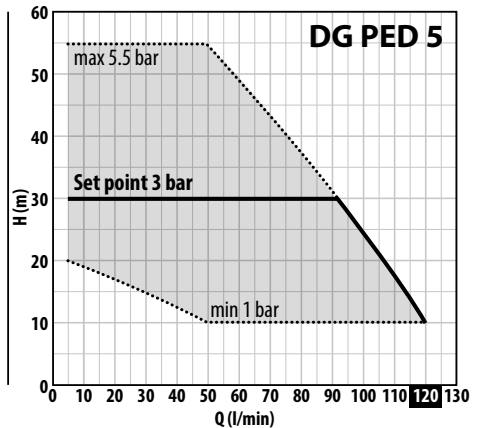
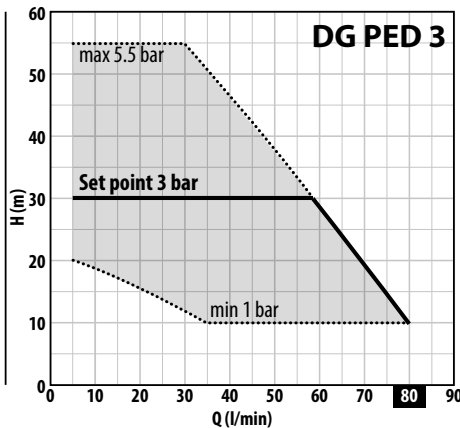

TYP	LEISTUNG		MAX. LEISTUNGEN	LEISTUNGEN (EINSTELLBARER SOLLWERT)						
				Q		H		Min. Sollwert		Max. Sollwert
	P2	▲	Q	H	bar	l/min	Standard-Eichungssollwert		bar	l/min
Einphasig	kW	HP	l/min	metri	bar	l/min	bar	l/min	bar	l/min
DG PED 3	0.75	1	5 – 80	55 – 10	1	35 – 80	3	5 – 58	5.5	5 – 30
DG PED 5	1.1	1.5	5 – 120	55 – 10	1	50 – 120	3	5 – 92	5.5	5 – 50

Q = Durchsatz H = Gesamtförderhöhe

Toleranzen der Leistungskurven laut EN ISO 9906 Grado 3B.

▲ Effizienzklasse des Drehstrommotors (IEC 60034-30-1)

Die angegebenen Leistungen beziehen sich auf einen Wasserdruck auf der Saugseite von -1 m Wassersäule (Ansaugung aus 1 m Tiefe). Wenn der Wasserpegel auf der Saugseite weiter unten liegt als die Einlauföffnung der Pumpe, werden die Leistungen entsprechend reduziert.

LEUCHTANZEIGEN

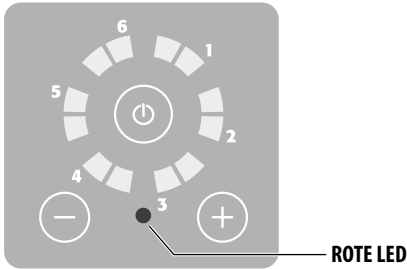

AUSSER BETRIEB

DG PED steht unter Spannung, ist aber außer Betrieb.

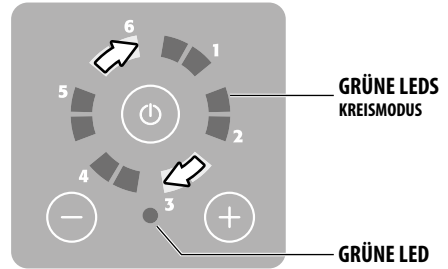

PUMPE IN BETRIEB

DG PED steht unter Spannung, und die Pumpe ist in Betrieb.

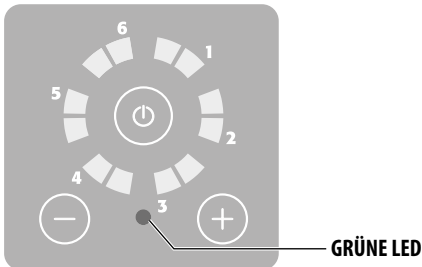

STANDBY

DG PED steht unter Spannung, aber die Pumpe ist nicht in Betrieb.

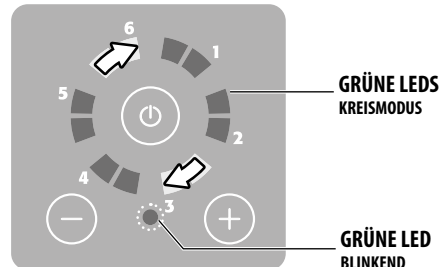

PUMPE IN DER STOPP-PHASE

DG PED steht unter Spannung, und die Pumpe ist in der Stopp-Phase.

INSTALLATION UND HYDRAULIKANSCHLÜSSE (nur für qualifiziertes Personal)



In der Phase der Erstinstallation sicherstellen, dass **KEINE SPANNUNG** am Stromnetz anliegt.



In der Phase der Erstinstallation und Wartung sicherstellen, dass die Anlage **NICHT MIT DRUCK BEAUFSCHLAGT IST**.

Sicherstellen, dass die Stromversorgungsleitung mit einer Schutzvorrichtung ausgerüstet ist, und zwar mit einem hochsensiblen Differentialschalter (30 mA der Klasse A) zum Schutz gegen wechselnde, einpolige, pulsierende, kontinuierliche, hochfrequente Fehlerströme. Außerdem muss überprüft werden, ob die Erdung vorschriftsmäßig ausgeführt wurde.

Überprüfen, dass die Daten auf dem Typenschild die gewünschten und für die Anlage geeigneten sind.

DG PED in einem Raum mit folgenden Merkmalen installieren:

- geschützt gegen externe Einflüsse;
- gut belüftet, ohne zu starke Feuchtigkeit und zu viel Staub;
- so beschaffen, dass das Gerät keinen schädlichen Schwingungen oder von den angeschlossenen Leitungen stammenden mechanischen Belastungen ausgesetzt ist.

- 1 Die StandfüÙe betätigen, um das DG PED korrekt zu nivellieren.

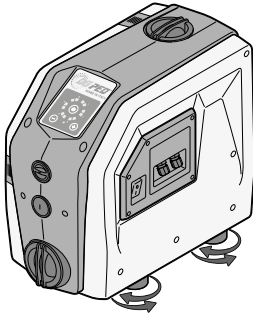

- 2 Die Gabeldeckel entfernen.

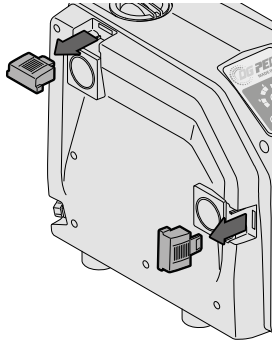

- 3 Die Gabeln entfernen.

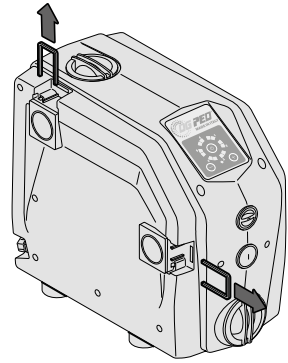

- 4 Die Krümmen samt O-Ring einfügen.

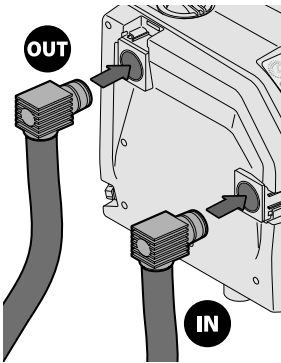

 Die Ansaugleitung muss einen Mindestquerschnitt von 1" aufweisen und perfekt versiegelt sein.

- 5 Die Gabeln korrekt einfügen.

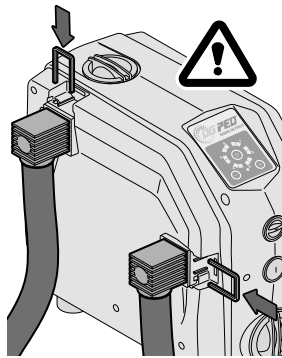

- 6 Die Gabeldeckel einsetzen.

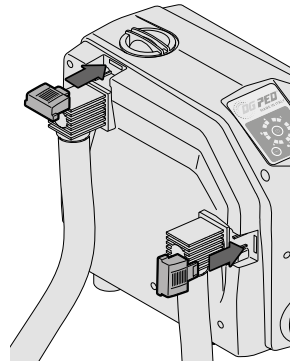

 Es kann ein Ausdehnungsgefäß zur Anlage hinzugefügt werden, das auf der Vorlaufseite (OUT) installiert werden muss.

AUFFÜLLEN UND EINSCHALTEN (nur für qualifiziertes Personal)

! DG PED nie im Trockenlauf betreiben, um die mechanische Dichtung nicht zu beeinträchtigen.

FALL A: Betrieb UNTER DEM PEGEL (Tank oder Wassernetz)

1 Alle Ventile öffnen, um die Wasserpumpe aufzufüllen.

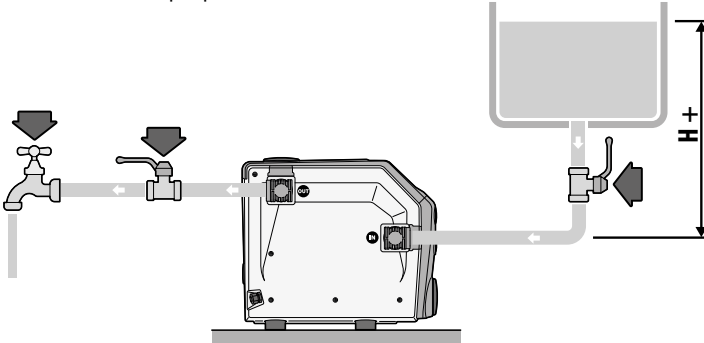

2 Den Stecker an das Stromnetz anschließen.

3 PortDen Schalter auf "I" stellen.

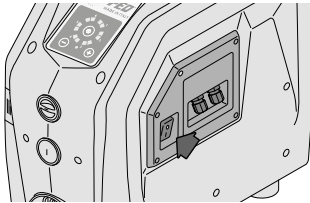

4 Die Taste  drücken, um das DG PED zu starten.



FALL B: Betrieb ÜBER DEM PEGEL (Ansaugung aus einer Wanne oder einem Brunnen)

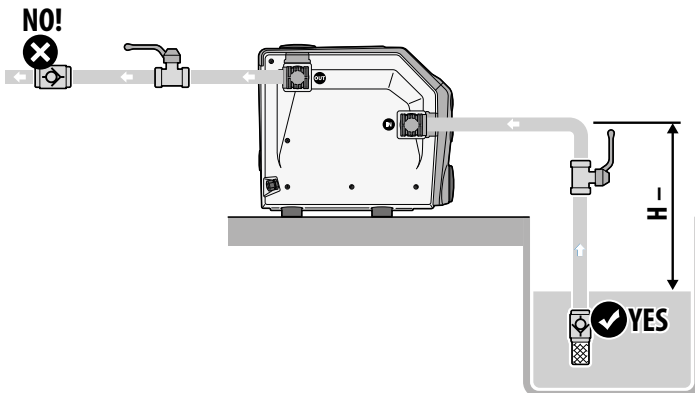

- 1 Den Verschluss zum Auffüllen und den Entlüftungsstopfen aufschrauben und entfernen.
- 2 Ungefähr 1.5 Liter Wasser einfüllen, bis Wasser aus der Entlüftungsöffnung austritt.
- 3 Den Verschluss zum Auffüllen und den Entlüftungsstopfen wieder zuschrauben.
- 4 Den Wasserhahn öffnen.

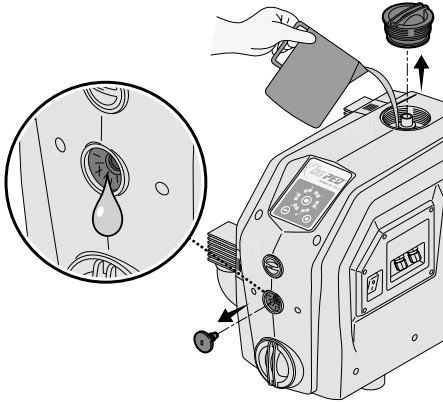

- 5 Den Stecker an das Stromnetz anschließen .
- 6 Den Schalter auf "I" stellen.

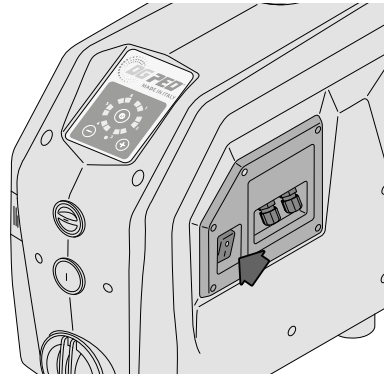

- 7 GLEICHZEITIG die Tasten ⊕ und ⊖ 5 Sekunden lang drücken. DG PED geht auf den Betrieb mit Ansaugung über.

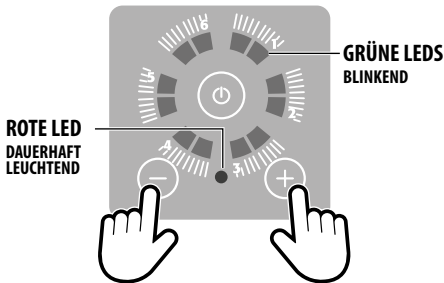

- 8 Die Taste ⏻ drücken, um das Ansaugen zu starten.

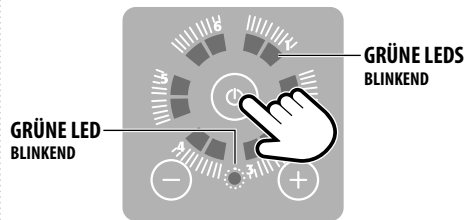

Das Ansaugverfahren dauert nicht länger als 5 Minuten, nach jeder abgelaufenen Minute stoppt das DG PED die Elektropumpe automatisch für 5 Sekunden und startet sie gleich danach wieder. Dieses Verfahren wird weitergeführt, solange das DG PED im Ansaugbetrieb ist. Während dieses Verfahrens bleiben die LEDS blinkend eingeschaltet.

Der Ansaugbetrieb kann wegen Timeout (5 Minuten) abgeschlossen werden, oder weil die Ansaugphase vervollständigt ist. Die LEDS hören dann zu blinken auf. Sollte die Pumpe nicht ansaugen, das Verfahren von vorn beginnen und wiederholen.

EINSTELLUNG DES BETRIEBSDRUCKS

Der BETRIEBSDRUCK wird über die grünen LEDS angezeigt, die an der Bedientafel eingeschaltet sind. Der BETRIEBSDRUCK des DG PED liegt im Bereich zwischen mindestens 1 bar und maximal 5.5 bar.

Für die Einstellung:

- Die Taste **+** drücken, um den BETRIEBSDRUCK anzuzeigen.
- Die Tasten **+** oder **-** drücken, um den BETRIEBSDRUCK zu erhöhen oder vermindern. Bei jedem Druck auf die Taste **+** oder **-** wird der Wert um einen Schritt von 0,5 bar erhöht oder vermindert.

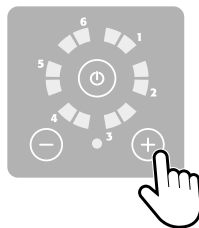

Beispiel

Die Taste **+** drücken, um den BETRIEBSDRUCK anzuzeigen
Wenn die grünen LEDS so eingeschaltet sind, wie auf der Abbildung, beträgt der Betriebsdruck **2 bar**.

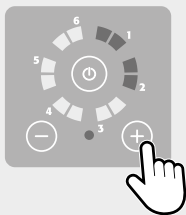

Um den Betriebsdruck zum Beispiel auf 3 bar zu erhöhen, zwei Mal die Taste **+** drücken.
Der Wert wird um 1 bar (0.5 + 0.5 bar) erhöht.

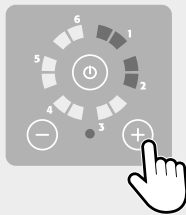

Die LEDS werden so eingeschaltet, wie auf der Abbildung. Betriebsdruck **3 bar**.



AUFPUMPEN DES AUSDEHNUNGSGEFÄSSES

(nur für qualifiziertes Personal)

Das Ausdehnungsgefäß im DG PED ist werkseitig auf einen Druckwert von 1,5 bar vorgeladen.

Das optimale Aufpumpen des Gefäßes gewährleistet den perfekten Betrieb des Systems und beugt vorzeitigen Brüchen der Membran vor.

! Das Gefäß muss aufgepumpt werden, wenn der Anlagendruck null beträgt. Maximaler Aufpumpdruck 4 bar.

**! Befüllen Sie das Ausdehnungsgefäß gemäß der Tabelle. Bei Arbeitsdrücken unter 3 bar befüllen Sie den Behälter 0,5 bar weniger als den Arbeitsdruck.
Beispiel: Arbeitsdruck = 2 bar,
Druck Ausdehnungsgefäß = 1.5 bar**

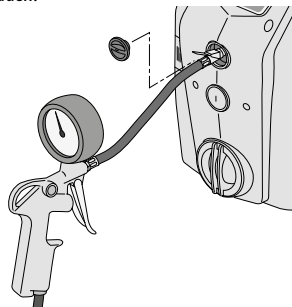

Um das Ausdehnungsgefäß aufzupumpen:

- Den Verschluss entfernen.
- Einen Verdichter beschaffen.
- Den Schlauch des Verdichters an das Ladeventil anschließen.
- Das Ausdehnungsgefäß auf den gewünschten Druckwert pumpen.

! Prüfen Sie den Luftdruck des Ausdehnungsgefäßes mindestens einmal pro Jahr. Befüllen Sie ihn ggf. wieder auf den entsprechenden Druck.

Betriebsdruck	Durch Pumpen zu erreichender Druck
3.0 bar	1.5 bar
3.5 bar	2.0 bar
4.0 bar	2.5 bar
4.5 bar	3.0 bar
5.0 bar	3.5 bar
5.5 bar	4.0 bar

WAHL DES BETRIEBS MIT AUTOMATISCHER ANSAUGUNG (nur für qualifiziertes Personal)

Die Pumpe verlässt das Werk in der Version mit AUTOMATISCHER ANSAUGUNG; wenn der Betrieb unter dem Pegel gewährleistet ist oder die Zufuhr bereits unter Druck erfolgt, kann die Funktion der automatischen Ansaugung ausgeschlossen werden, indem der unten abgebildete Hebel in die vertikale Position gedreht wird.

- 1 Den Verschluss zum Entleeren aufschrauben und entfernen. Möglicher Austritt von Wasser.

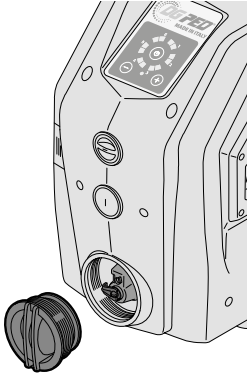

- 2 Den roten Hebel in die vertikale Stellung drehen, um den automatischen Ansaugbetrieb auszuschließen.

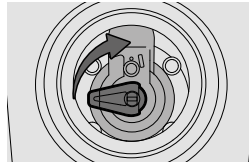

MIT AUTOMATISCHER ANSAUGUNG (werkseitige Einstellung)

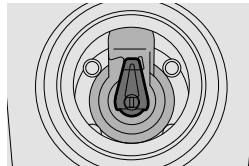

KEINE AUTOMATISCHE ANSAUGUNG

- 3 Den Verschluss zum Entleeren wieder zuschrauben. DG PED erneut mit Wasser auffüllen, wie es im Kapitel AUFFÜLLEN UND EINSCHALTEN beschrieben wird.

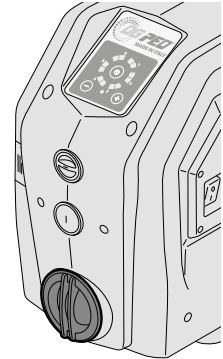

OPTIONAL

ELEKTRISCHE ANSCHLÜSSE DER ERWEITERUNGSKARTE (nur für qualifiziertes Personal)

⚡ Sicherstellen, dass KEINE SPANNUNG am Stromnetz anliegt

ACHTUNG: Jede an die Erweiterungskarte angeschlossene Vorrichtung muss eine sehr niedrige Sicherheitsspannung (SELV) aufweisen.

⚠ Beim Entfernen des Deckels nicht an den Stromkabeln ziehen, die mit dem Hauptschalter verbunden sind.

- Die Befestigungsschrauben des Deckels aufschrauben und entfernen.
- Den Deckel teilweise entfernen, um Zugriff auf das Klemmbrett der Erweiterungskarte zu erhalten.

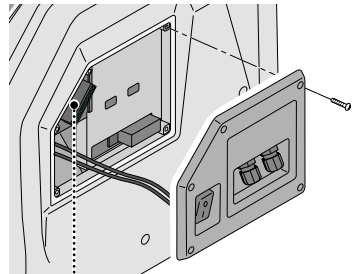

LEGENDE DER KLEMMLEISTE

1-2	INPUT	FÜLLSTANDSIGNAL - überbrücken, wenn kein Signal vorhanden ist
3-4	OUTPUT	OUTPUT ALARMSIGNAL - max 0,3 A @ 230 Va.c. / 1A @ 30 Vd.c.
5-6	RS 485	Kommunikation MASTER / SLAVE
7-8	0V	nicht angeschlossen
9-10	SLAVE	wenn überbrückt, wird der Inverter SLAVE

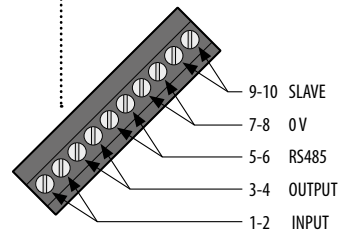

ALARME

GRÜNE LED BLINKEND + ROTE LED BLINKEND

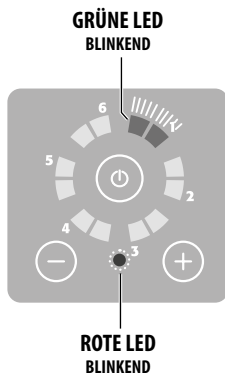

- ALARM 1** = Trockenlauf. Wird ausgelöst, wenn 7 Sekunden lang auf der Saugseite kein Wasser vorhanden ist. Überprüfen, ob Wasser angesaugt wird und die Pumpe auffüllen.
DG PED führt nach 1 Minute, 15 Minuten, 30 Minuten, 1 Stunde, 1 Stunde, usw. automatische Versuche für den Neustart aus.
- ALARM 2** = Die Pumpe erreicht den eingestellten Druckwert nicht. Ein Kundendienstzentrum kontaktieren.
- ALARM 3** = Der Druck der Vorladung des Ausdehnungsgefäßes ist zu niedrig; das Gefäß auf 50% des Betriebsdrucks pumpen (zum Beispiel bei Betriebsdruck 3 bar das Gefäß auf 1.5 bar pumpen).
- ALARM 4** = Vorlaufdruck geringer als 0.2 bar (defekte Leitung). Nur manuelle Rücksetzung. Ermitteln, warum der Druck auf null gesunken ist.
- ALARM 5** = Zu niedrige Versorgungsspannung.
Für die Stromversorgung 230 V +/- 10 % garantieren.
- ALARM 6** = OFF-Signal von außen.

GRÜNE LED DAUERHAFT EINGESCHALTET + ROTE LED BLINKEND

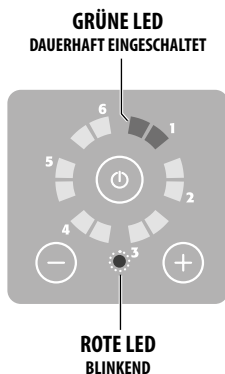

- ALARM 1** = Kurzschluss. Die Vorrichtung ausschalten und den Kundendienst kontaktieren. Nur manuelle Rücksetzung.
- ALARM 2** = Überstrom. Die Stromaufnahme überschreitet die zulässige Toleranz. Nur manuelle Rücksetzung. Wenn das Problem weiterhin bestehen bleibt, ein Kundendienstzentrum kontaktieren.
- ALARM 3** = Zu hohe Temperatur des Moduls. Prüfen Sie die Temperatur der geförderten Flüssigkeit. Wenn die Flüssigkeit keine höhere Temperatur als 40 °C hat, wenden Sie sich an die Servicestelle. Automatische Rücksetzung, wenn die Temperatur unter den Alarmwert sinkt.
- ALARM 4** = Zu hohe Temperatur des Moduls. Die Temperatur der gepumpten Flüssigkeit überprüfen. Wenn die Flüssigkeit eine Temperatur von nicht mehr als 40 °C aufweist, ein Kundendienstzentrum kontaktieren. Automatische Rücksetzung, wenn die Temperatur unter den Alarmwert sinkt.
- ALARM 5** = Signal des Drucksensors nicht gültig. Ein Kundendienstzentrum kontaktieren.
- ALARM 6** = Signal des Durchflusssensors nicht gültig. Ein Kundendienstzentrum kontaktieren.

Esempio:
pompa in allarme per
MARCIA A SECCO

LED 1 LAMPEGGIANTE
+
LED ROSSO LAMPEGGIANTE
=
MARCIA A SECCO

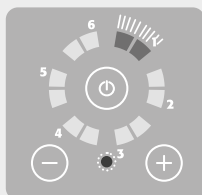

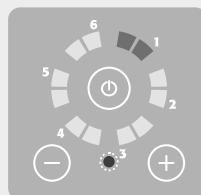

Esempio:
pompa in allarme per
CORTO CIRCUITO

LED 1 FISSO
+
LED ROSSO LAMPEGGIANTE
=
CORTO CIRCUITO



STÖRUNGSSUCHE

PROBLEM	LED-ANZEIGE	EINGRIFF
Die Tastatur schaltet sich nicht ein.	LEDS ausgeschaltet.	Überprüfen, ob der seitliche Schalter auf "I" steht.
		 Überprüfen, ob die Stromversorgung vom Netz vorhanden ist, überprüfen, ob der Differentialschalter geeignet ist.
Die Pumpe startet beim Öffnen eines Verbrauchers nicht.	Rote LED dauerhaft leuchtend.	Die Pumpe durch Drücken der Taste I/O in Betrieb setzen.
	Rote Led blinkend eingeschaltet.	Im Verzeichnis der Alarme auf den vorherigen Seiten nachsehen.
	Grüne Led dauerhaft leuchtend.	Der Anlagendruck sinkt nicht unter den eingestellten Betriebsdruck.
Alarm TROCKENBETRIEB.	Rote LED blinkend, Grüne LEDES in Position 1, blinkend.	Überprüfen, ob bei der Ansaugung Wasser vorhanden ist. Überprüfen, dass bei der Ansaugung keine Verstopfung vorliegt. Die Pumpe auffüllen und ansaugen lassen.
Alarm KURZSCHLUSS.	Rote LED blinkend, Grüne LEDES in Position 1, dauerhaft leuchtend.	 Überprüfen, dass die Pumpe nicht verstopft ist, indem der hintere Stopfen des Motors geöffnet und die Welle gedreht wird.
		 Überprüfen, dass das Kabel, der Stecker und die Buchse unversehrt sind und kein Streustrom vorhanden ist.
Alarm NIEDRIGER DRUCK.	Rote LED blinkend, Grüne LEDES in Position 5, blinkend.	Die Spannung liegt um mehr als 15 % unter dem auf dem Typenschild angegebenen Wert; die Spannung stabilisieren, um sie innerhalb der Grenzen von +/- 15 % beizubehalten.
Pumpe stoppt und startet ständig neu	LED im normalen Betriebszustand	Prüfen Sie, ob der Druck im Ausdehnungsgefäß korrekt ist. Suchen Sie nach Undichtigkeiten im System und beseitigen Sie diese.

WARTUNG (nur für qualifiziertes Personal)

INSPEKTION UND REINIGUNG DES RÜCKSCHLAGVENTILS

Das RÜCKSCHLAGVENTIL befindet sich innerhalb der Saugöffnung.

Zum Entfernen:

- 1 Druck aus dem System entfernen.
- 2 Entfernen Sie die Abdeckung und den Sicherungsbügel (A).
- 3 Entfernen Sie den Saugstutzen / Winkelverschraubung (B).
- 4 Entnehmen Sie das RÜCKSCHLAGVENTIL (C).
- 5 Überprüfen / reinigen Sie das RÜCKSCHLAGVENTIL (C).
- 6 Setzen Sie das RÜCKSCHLAGVENTIL (C) wieder richtig in die Saugöffnung.
- 7 Setzen Sie den Saugstutzen / Winkelstück wieder in die Saugöffnung (B), fixieren ihn mit dem Sicherungsbügel und setzen die Abdeckung wieder drauf (A).

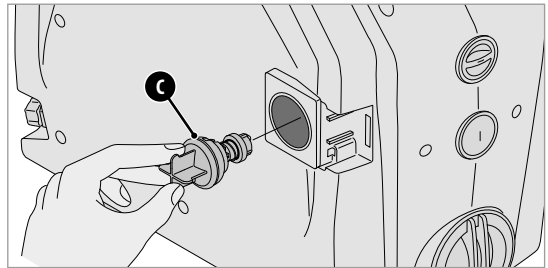
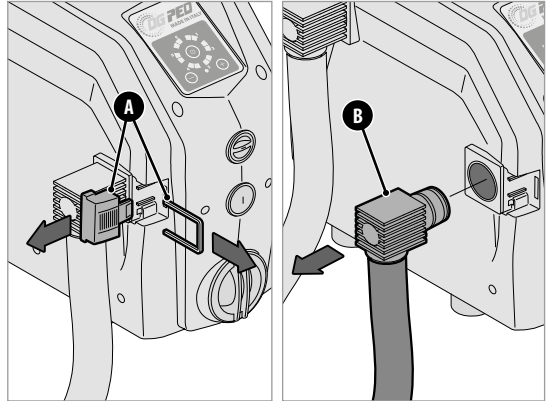

INSPEKTION UND REINIGUNG DES DURCHFLUSSREGELVENTILS

- 1 **Nachdem Sie den Druck aus dem System entfernt haben**, schrauben Sie den EINFÜLLSTOPFEN (D) ab und entfernen Sie ihn.
- 2 Entfernen Sie die DURCHFLUSSREGELVENTIL-Gruppe (E), indem Sie die Befestigungsschraube lösen. Inspizieren und reinigen Sie es.
- 3 Montieren Sie die DURCHFLUSSREGELVENTIL-Gruppe (E). Stellen Sie sicher, dass die Ausrichtung korrekt ist!! Schrauben Sie die Befestigungsschraube wieder fest.
- 4 Schrauben Sie den EINFÜLLSTOPFEN (D) richtig ein.

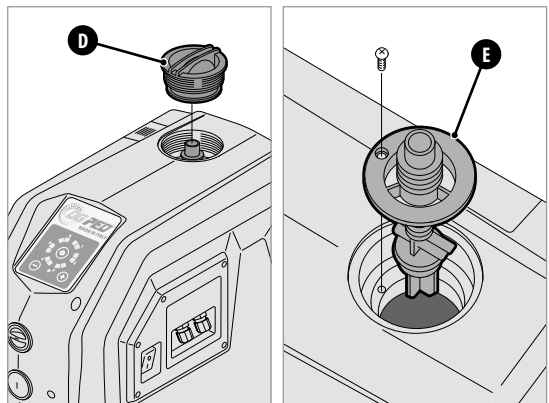

ABMESSUNGEN (mm)

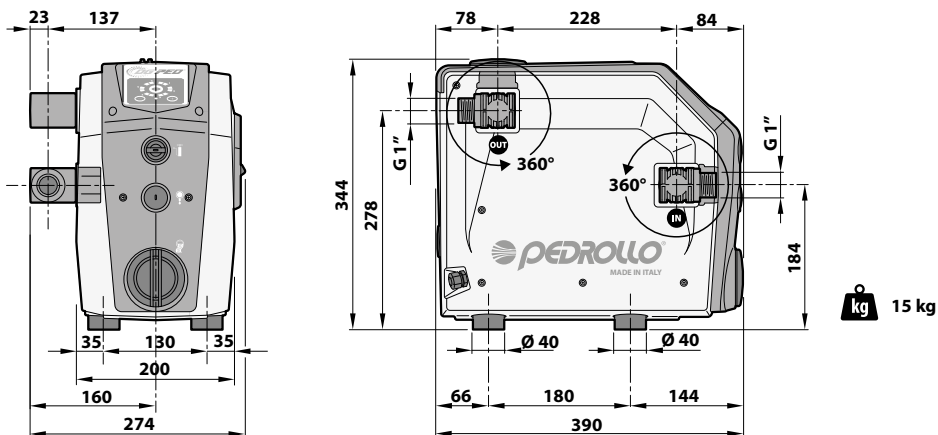

GARANTIE

Vor der Installation und dem Gebrauch des Geräts das gesamte vorliegende Handbuch aufmerksam durchlesen. Die Installation und Wartung muss von qualifiziertem Fachpersonal vorgenommen werden, das dafür verantwortlich ist, dass die Wasser- und Elektroanschlüsse den anwendbaren Vorschriften entsprechend ausgeführt werden.

Der Hersteller lehnt jede Haftung ab für Schäden, die durch nicht zweckmäßigen Gebrauch des Geräts entstehen, und er ist nicht haftbar für Schäden, die durch Wartungs- oder Reparatureingriffe auftreten, die von nicht qualifiziertem Personal und/oder mit nicht originalen Ersatzteilen ausgeführt werden. Der Gebrauch von nicht originalen Ersatzteilen, Manipulationen oder nicht zweckmäßige Verwendung führen zum Verfall der Garantie für das Gerät.

ENTSORGUNG

Für die Entsorgung der Bauteile, aus denen das DG PED besteht, müssen die in den Ländern geltenden Vorschriften und Gesetze eingehalten werden, in denen die Einheit verwendet wird.

Keine umweltschädlichen Teile in die Umwelt gelangen lassen.



Korrekte Entsorgung von Elektro- und Elektronik-Altgeräten (RICHTLINIE 2012/19/UE)

KONFORMITÄTSERKLÄRUNG



Wir erklären in alleiniger Verantwortung, dass das betreffende Produkt den Bestimmungen der folgenden Gemeinschaftsrichtlinien, einschließlich der letzten Änderungen, und den einschlägigen nationalen Rechtsvorschriften zu ihrer Umsetzung entspricht: 2006/42/EU, 2014/35/EU, 2014/30/EU, 2009/125/EU, 547/2012/EU, 2011/65/EU, 2015/863/EU, 1907/2006/EU, 2012/19/UE

San Bonifacio, 25/02/2022

Pedrollo S.p.A.
Der Präsident
Silvano Pedrollo

ÍNDICE

INFORMAÇÕES GERAIS.....	75
NORMAS DE SEGURANÇA	75
DESCRIÇÃO DO PRODUTO.....	76
DADOS TÉCNICOS	77
LIMITES DE UTILIZAÇÃO.....	77
CURVAS DE RENDIMENTO	77
SINALIZAÇÕES LUMINOSAS.....	78
INSTALAÇÃO E LIGAÇÕES HIDRÁULICAS	78
ENCHIMENTO E PARTIDA.....	80
REGULAGEM DA PRESSÃO DE TRABALHO	82
ENCHIMENTO DO VASO	82
SELEÇÃO DO FUNCIONAMENTO AUTOESCORVANTE	83
LIGAÇÕES ELÉTRICAS FICHA DE EXPANSÃO.....	83
ALARMES	84
PROCURA DAS AVARIAS.....	85
MANUTENÇÃO.....	86
DIMENSÕES E PESOS.....	87
GARANTIA	87
ELIMINAÇÃO.....	87
DECLARAÇÃO DE CONFORMIDADE.....	87

INFORMAÇÕES GERAIS

Instruções originais para a utilização.

Este manual deve acompanhar sempre o equipamento a que diz respeito e deve ser conservado num lugar de fácil acesso para poder ser consultado pelas pessoas encarregadas da utilização e da manutenção do sistema.

Recomenda-se ao instalador/utilizador a leitura minuciosa das prescrições e das informações contidas neste manual antes de utilizar o produto, a fim de evitar danos no equipamento, a sua utilização inadequada e a anulação da garantia. Este produto não deve ser utilizado por crianças ou por pessoas com capacidades físicas, sensoriais ou mentais reduzidas, ou que não possuam experiência e conhecimentos, a não ser que tenham sido formados e supervisionados. As crianças devem ser vigiadas para verificar que não brinquem com o equipamento.

A firma fabricante não pode ser responsabilizada por acidentes ou danos devidos a negligência ou ao não cumprimento das instruções contidas neste livrete ou a utilização em condições diferentes das indicadas na placa. Também não pode ser responsabilizada por danos causados por uma utilização não adequada da eletrobomba. Não sobrepor pesos ou outras caixas à embalagem.

NORMAS DE SEGURANÇA

Neste manual foram utilizados símbolos que têm o significado seguinte.



Este símbolo avisa de que o não cumprimento da prescrição acarreta perigo de choques elétricos.



Este símbolo avisa de que o não cumprimento da prescrição acarreta perigo de danos a pessoas ou coisas.



ANTES DE INSTALAR E UTILIZAR O PRODUTO:

- ler com atenção o presente manuale em todas as suas partes;
- controlar que os dados nominais da placa sejam os desejados e adequados para a instalação;
- a instalação e a manutenção devem ser executadas por pessoal qualificado, responsável pela realização das ligações elétricas em conformidade com as normas de instalação nacionais;

- o fabricante não pode ser responsabilizado por danos derivados de uma utilização inadequada do produto e não é responsável por danos causados por manutenções ou reparações efetuadas por pessoal não qualificado e/ou com peças de reposição não de origem;
- a utilização de peças de reposição não de origem, modificações ou utilizações inadequadas anulam a garantia do produto.



DURANTE A PRIMEIRA INSTALAÇÃO E EM CASO DE MANUTENÇÃO, VERIFICAR QUE:

- Não haja corrente na rede de alimentação elétrica.
- A rede de alimentação elétrica esteja dotada de proteções e em particular de interruptor diferencial de alta sensibilidade (30 mA em classe A) apto para proteger contra correntes de avaria de tipo alternado, unipolar pulsante, contínuo, de alta frequência. Verificar também que o aterramento seja em conformidade com as normas.
- Antes de remover a tampa do DG PED ou começar operações nele, é necessário desligar a instalação da rede elétrica e aguardar pelo menos 5 minutos para que os condensadores tenham o tempo de se descarregar através dos resistores de descarga incorporados.



ATENÇÃO: em estado de fora de serviço (LED vermelho aceso) o DG PED continua sob tensão; antes de qualquer intervenção é obrigatório desligar a tensão do grupo.



PARADA DE EMERGÊNCIA

- Enquanto o DG PED está a funcionar, é possível efetuar uma parada de emergência, premindo na tecla I/O.
- Nas aplicações com duas unidades em paralelo, somente o inversor MASTER bloqueia o sistema.



Durante a primeira instalação e em caso de manutenção, verificar que NÃO HAJA CORRENTE na rede elétrica.



Durante a primeira instalação e em caso de manutenção, verificar que o sistema NÃO ESTEJA EM PRESSÃO.



NÃO ABRIR AS TAMPAS DO INVERSOR com exceção da tampa dos conectores.

DESCRIÇÃO DO PRODUTO

O **DG PED** é um sistema de pressurização automático com inversor que abrange no seu interior: uma eletrobomba autodescorvante de alta eficiência, um vaso de acumulação de grande capacidade, os sensores de pressão e de fluxo, uma válvula anti-retorno.

Um verdadeiro sistema de bombagem compato, silencioso e de grandes rendimentos.

Um apurado controle eletrónico com inversor controla de maneira inteligente e intuitiva o inteiro sistema:

- mantém constante a pressão da instalação regulando a velocidade da bomba em função do pedido hídrico;
- controla os parâmetros de funcionamento hidráulicos e elétricos e protege a eletrobomba das anomalias;
- pode estar provido de ficha de expansão que permite trabalhar em paralelo com outros inversores nos grupos de bombagem e de gerir sinais em entrada e em saída;
- adapta-se a qualquer tipo de instalação de pressurização,

também existente. Onde as normas o permitam, o aparelho está apto para utilização em rede hídrica. Neste caso, inserir uma válvula anti-retorno a montante;

- limita as correntes de partida e de funcionamento para uma maior poupança energética.

Nas aplicações em paralelo, distinguem-se um inversor MASTER e inversores SLAVE, controlados pelo MASTER.

O MASTER recebe a programação dos parâmetros e controla os dados de funcionamento, e ativa e desativa os SLAVE conforme as necessidades.



Se o MASTER for desligado, os SLAVE voltam a ser autónomos e continuam a funcionar independentemente.

Quando trabalhar em configuração paralela com outros inversores, o DG PED administra a alternância das partidas, para uniformizar a utilização das bombas.

LISTA DAS PARTES

1. Interruptor geral bipolar I/O
2. Passacabos sinais INPUT/OUTPUT
3. Painel de controle
4. Bujão de enchimento
5. Tampão vaso de expansão
6. Tampão de drenagem
7. Bujão de descarga
8. Ficha de expansão
9. Fusível 12.5 A (de ação rápida)
10. Estribo de bloqueio conetor
11. Junção em cotovelo orientável, com OR
12. Boca de compressão (OUT)
13. Boca de aspiração (IN)
14. Pés antivibrações
15. Cabo de alimentação

PAINEL DE CONTROLE

16. Tecla para ligar / desligar 
17. Indicadores LED de cor verde que assinalam:
 - bomba em funcionamento;
 - pressão de trabalho;
 - alarmes
18. Indicadores LED de cor verde ou vermelha
19. Teclas  e  de aumento e diminuição valores

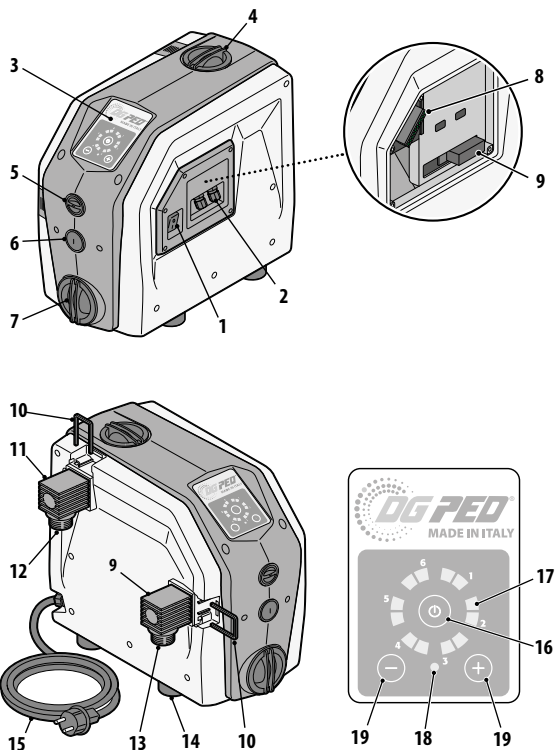

DADOS TÉCNICOS

- Tensão de alimentação ~ **230 V ± 10%**
- Frequência **50/60 Hz**
- Isolamento: classe **F**
- Corrente máxima absorvida
 - **7,5 A** DG PED 3
 - **10 A** DG PED 5
- P1 Potência máxima absorvida:
 - **1,0 kW** DG PED 3
 - **1,5 kW** DG PED 5
- Proteção **IP X4**
- Set point de fábrica **3 bar**
- Fusível **12.5 A** (de ação rápida)

LIMITES DE UTILIZAÇÃO

- Altura de aspiração manométrica até **8 m**
- Temperatura do líquido de **0 °C** até **+40 °C**
- Temperatura ambiente de **0 °C** até **+40 °C**
- Pressão máx. **10 bar**
- Serviço contínuo **S1**
- Posição de trabalho vertical



ÁGUAS LIMPAS



USO DOMÉSTICO



USO RESIDENCIAL

CURVAS DE RENDIMENTO

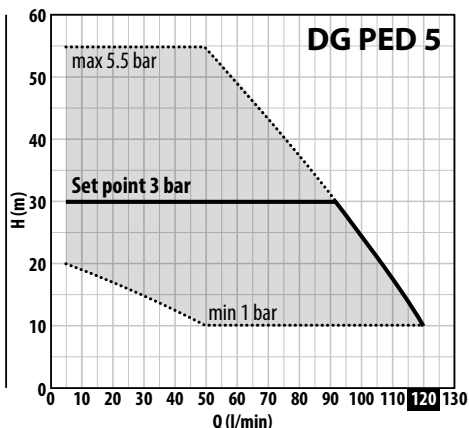
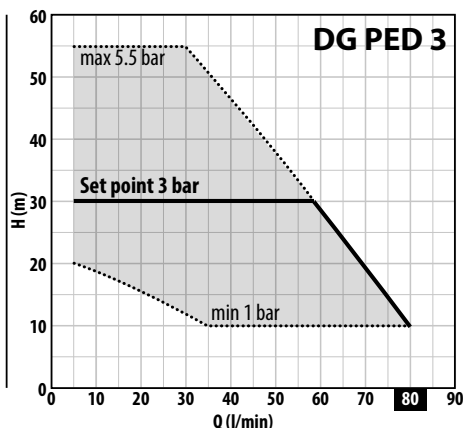

TIPO	POTÊNCIA		RENDIMENTOS MÁX		RENDIMENTOS (SET POINT AJUSTÁVEL)						
	P2		Q	H	Set Point Mín		Set Point Ajuste Std		Set Point Máx		
Monofásico	kW	HP	▲	l/min	metri	bar	l/min	bar	l/min	bar	l/min
DG PED 3	0.75	1	IE3	5 – 80	55 – 10	1	35 – 80	3	5 – 58	5.5	5 – 30
DG PED 5	1.1	1.5		5 – 120	55 – 10	1	50 – 120	3	5 – 92	5.5	5 – 50

Q = Débito H = Altura manométrica total

Tolerância das curvas de rendimento segundo EN ISO 9906 Grau 3B.

▲ Classe de rendimento do motor trifásico (IEC 60034-30-1)

Os rendimentos indicados referem-se a um nível de aspiração de -1 m (aspiração de 1 m). Se o nível da água na aspiração for inferior à cota de embocadura da bomba, os rendimentos serão reduzidos proporcionalmente.

SINALIZAÇÕES LUMINOSAS

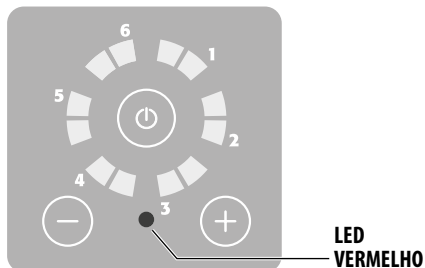

FORA DE SERVIÇO

O DG PED está sob tensão mas fora de serviço.

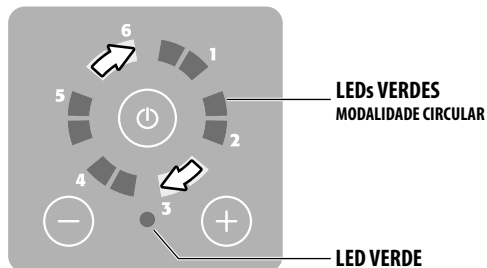

BOMBA EM FUNCIONAMENTO

O DG PED está sob tensão e a bomba está a funcionar.

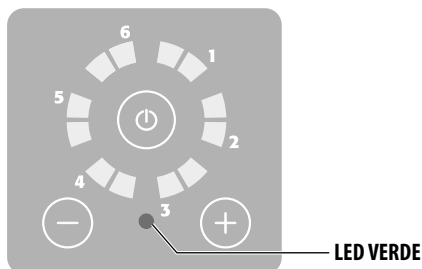

STAND-BY

O DG PED está sob tensão mas a bomba não está a funcionar.

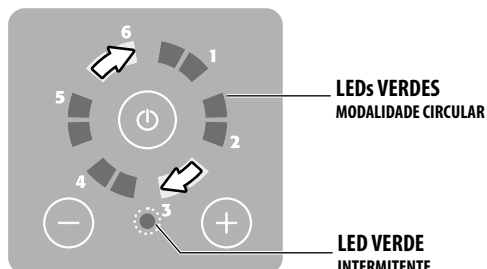

BOMBA EM FASE DE PARADA

O DG PED está sob tensão e a bomba está em fase de parada.

INSTALAÇÃO E LIGAÇÕES HIDRÁULICAS (só para pessoal qualificado)



Durante a primeira instalação e em caso de manutenção, verificar que **NÃO HAJA CORRENTE** na rede elétrica.



Durante a primeira instalação e em caso de manutenção, verificar que o sistema **NÃO ESTEJA EM PRESSÃO**.

Certificar-se de que a rede de alimentação elétrica está provida de proteções e em especial de um interruptor diferencial de alta sensibilidade (30 mA em classe A) apto para proteger contra correntes de avaria de tipo alternado, unipolar pulsante, contínuo, de alta frequência. Verificar também que o aterramento seja em conformidade com as normas.

Verificar que os dados nominais de placa sejam os desejados e adequados para a instalação.

Instalar o DG PED num local:

- ao abrigo dos agentes externos;
- ventilado, sem humidade nem poeiras excessivas;
- de modo a que não receba vibrações ou esforços mecânicos das tubagens ligadas.

- 1 Regular os pés para nivelar corretamente o DG PED.

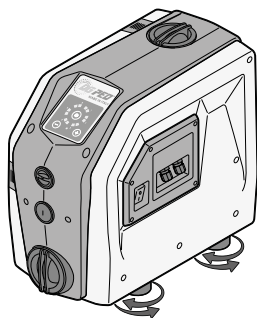

- 2 Remover os tampos do estribo.

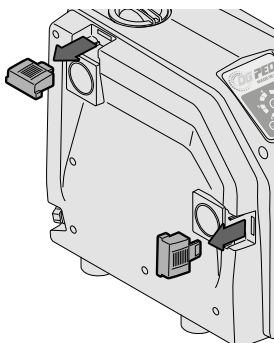

- 3 Remover os estribos.

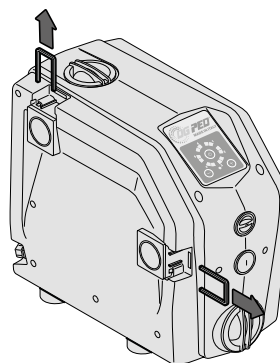

- 4 Inserir as junções em cotovelo completas de O-RING.

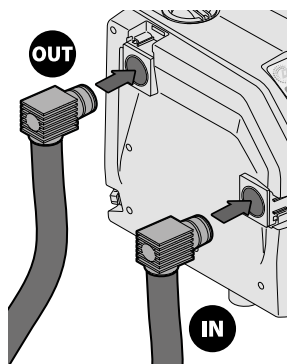

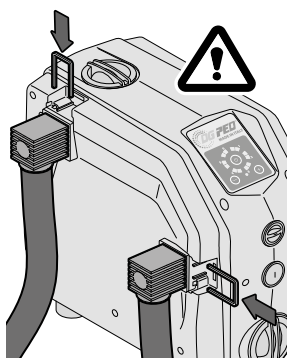

 O tubo de aspiração deve ter um diâmetro mínimo de 1" e deve ser perfeitamente estanque.

- 5 Inserir corretamente os estribos.

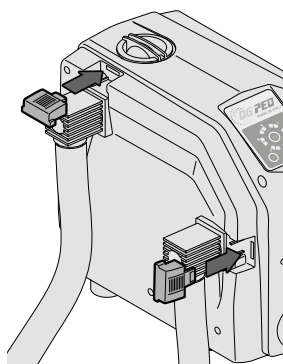

- 6 Inserir os tampos dos estribos.



 É possível acrescentar à instalação um vaso de expansão, instalado no lado da compressão (OUT).

ENCHIMENTO E PARTIDA (só para pessoal qualificado)

 Nunca deixar funcionar DG PED em seco, para não danificar o vedante mecânico.

CASO A: funcionamento ABAIXO DO NÍVEL DO LÍQUIDO (reservatório ou aqueduto)

1 Abrir todas as válvulas para encher a bomba de água.

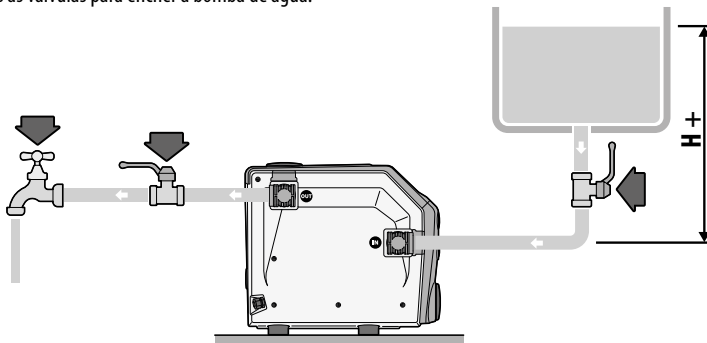

2 Ligar a ficha à rede elétrica .

3 Colocar o interruptor em "1".

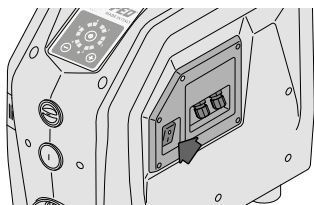

4 Premir a tecla  para o DG PED arrancar.



CASO B: funcionamento ACIMA DO NÍVEL DO LÍQUIDO (sucção de tanque ou de poço)

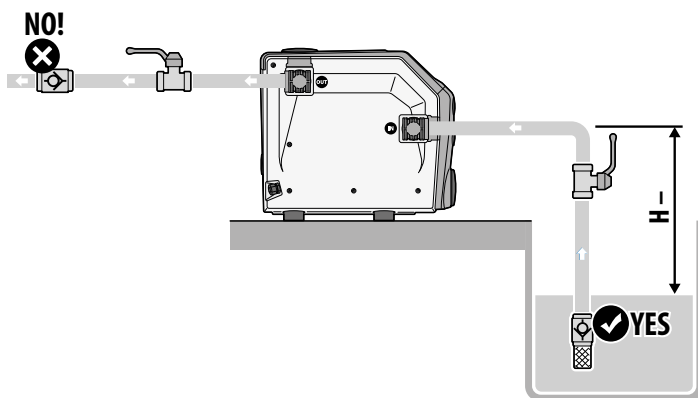

- 1 Desapertar e remover o bujão de enchimento e o tampão de drenagem.
- 2 Deitar aproximadamente 1,5 litros de água até ela sair do orifício de drenagem.
- 3 Voltar a apertar o bujão de enchimento e o tampão de drenagem.
- 4 Abrir a torneira da água.

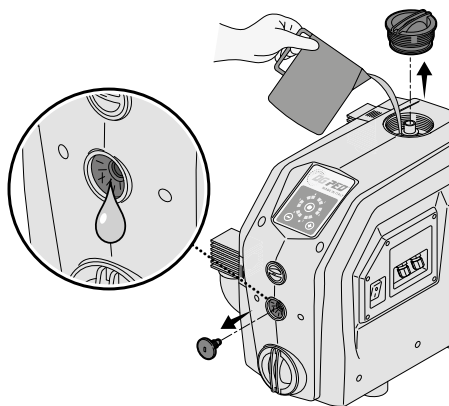

- 5 Ligar a ficha à rede elétrica.
- 6 Colocar o interruptor em "I".

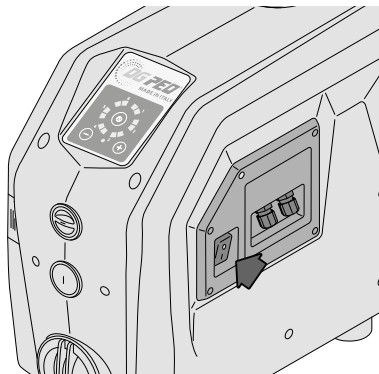

- 7 Premir SIMULTANEAMENTE as teclas \oplus e \ominus durante 5 segundos. O DG PED entra na modalidade escorva.

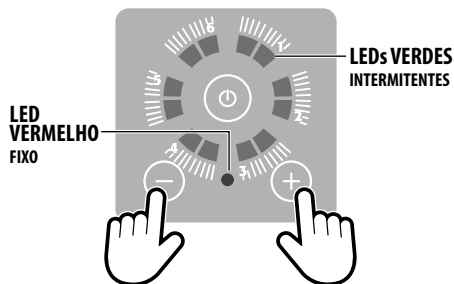

- 8 Premir a tecla ⏻ para iniciar a escorva.

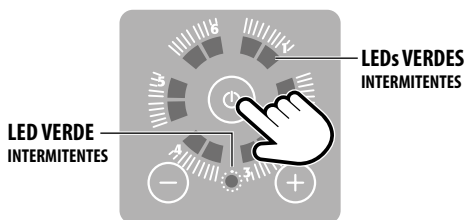

O procedimento de escorva demora ao máximo 5 minutos, no fim de cada minuto o DGPED automaticamente pára a eletrobomba por 5 segundos e a põe novamente em funcionamento uma vez passados. E assim por diante durante todo o tempo em que o DGPED ficará em escorva. Durante este procedimento os leds continuarão a piscar.

A saída do procedimento de escorva pode ocorrer por time out (5 minutos) ou por fase de escorva completada. Os leds deixam de piscar. Se a bomba não escorvar, repetir novamente a operação desde o início.

REGULAGEM DA PRESSÃO DE TRABALHO

A PRESSÃO DE TRABALHO é visualizada através dos LEDs de cor verde que acendem no painel de controle.

A PRESSÃO DE TRABALHO do DG PED abrange de um mínimo de 1 bar a um máximo de 5,5 bar.

Para a regulagem:

- Premir a tecla **+** para visualizar a PRESSÃO DE TRABALHO.
 - Premir as teclas **+** ou **-** para aumentar ou diminuir a PRESSÃO DE TRABALHO.
- A cada pressão da tecla **+** ou **-** aumenta-se ou diminui-se o valor em degraus de 0,5 bar.

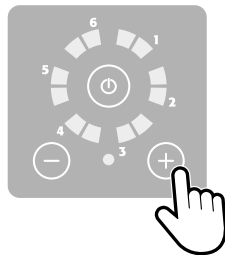

Exemplo

Premir a tecla **+** para visualizar a PRESSÃO DE TRABALHO

Com os leds verdes acesos como ilustrado na figura, a pressão de trabalho é de **2 bar**.

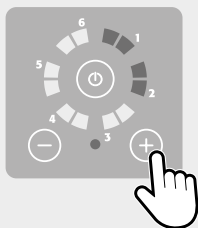

Para levar a pressão de trabalho por exemplo a 3 bar premir duas vezes a tecla **+**.

O valor aumenta de 1 bar (0,5+0,5 bar).

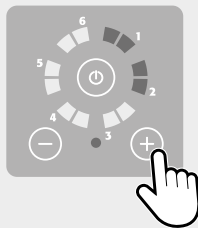

Os leds acendem como ilustrado na figura. Pressão de trabalho **3 bar**.



ENCHIMENTO DO VASO (só para pessoal qualificado)

O vaso de expansão no interior do DG PED é pré-carregado na fábrica a 1,5 bar.

O melhor enchimento do vaso garante o funcionamento perfeito do sistema e protege contra roturas prematuras da membrana.

! O enchimento do vaso deve ocorrer com sistema com pressão nula. Pressão máxima de enchimento 4 bar.

! Encha o vaso de expansão como mostrado na tabela. Para pressões de trabalho inferiores a 3 bar, encher o vaso com 0,5 bar menos da pressão do que a pressão de trabalho.

**Exemplo: pressão de trabalho = 2 bar,
pressão de inflação = 1.5 bar**

Para encher o vaso de expansão:

- Remover o tampão.
- Aprontar um compressor.
- Ligar o tubo do compressor à válvula de enchimento.
- Encher o vaso de expansão à pressão desejada.

! Verifique a pressão de enchimento do vaso pelo menos uma vez por ano. Se necessário restaurá-la ao seu valor de enchimento esperado.

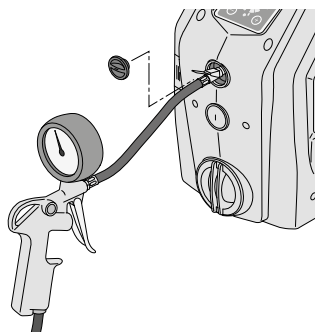

Pressão de trabalho	Pressão de enchimento
3.0 bar	1.5 bar
3.5 bar	2.0 bar
4.0 bar	2.5 bar
4.5 bar	3.0 bar
5.0 bar	3.5 bar
5.5 bar	4.0 bar

SELEÇÃO FUNCIONAMENTO AUTOESCORVANTE (só para pessoal qualificado)

A bomba sai da fábrica em versão AUTOESCORVANTE; caso esteja garantido o funcionamento abaixo do nível do líquido, ou se a alimentação já estiver em pressão, é possível desativar a função de autoescorva, rodando a alavanca indicada abaixo para a posição vertical.

- 1 Desapertar e retirar o bujão de descarga. Possível saída de água.

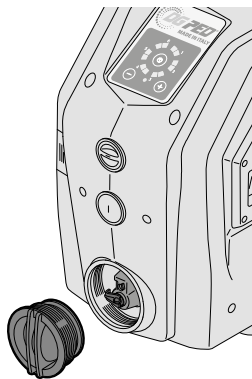

- 2 Rodar a alavanca vermelha para a posição vertical para desativar o funcionamento autoescorvante.

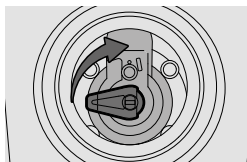

AUTOESCORVANTE
(regulagem de fábrica)

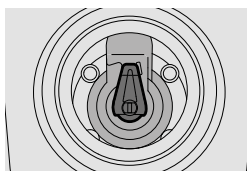

NÃO AUTOESCORVANTE

- 3 Voltar a apertar o bujão de descarga. Encher novamente de água DG PED como indicado no capítulo ENCHIMENTO E PARTIDA.

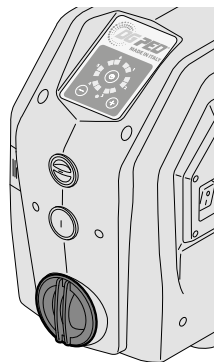

LIGAÇÕES ELÉTRICAS DA FICHA DE EXPANSÃO (só para pessoal qualificado)



Certificar-se de que **NÃO HÁ CORRENTE** na rede elétrica.

ATENÇÃO: qualquer dispositivo ligado à ficha de expansão deve ter baixíssima tensão de segurança (SELV).



Durante a remoção da tampa não puxar os cabos elétricos ligados ao interruptor geral.

- Desapertar e retirar os parafusos de fixação da tampa.
- Remover parcialmente a tampa para ter acesso à régua de bornes da ficha de expansão.

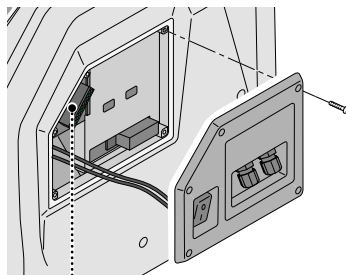

LEGENDA RÉGUA DE BORNES

- | | | |
|------|--------|--|
| 1-2 | INPUT | SÍGNAL DE NÍVEL – ligar em ponte com falta de sinal |
| 3-4 | OUTPUT | SÍGNAL DE ALARME - max 0,3 A @ 230 Va.c. / 1A @ 30 Vd.c. |
| 5-6 | RS 485 | comunicação MASTER / SLAVE |
| 7-8 | 0V | não ligado |
| 9-10 | SLAVE | se ligado em ponte, o inversor torna-se SLAVE |

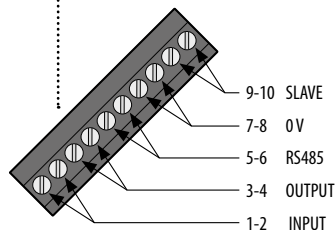

ALARMES

LED VERDE INTERMITENTE + LED VERMELHO INTERMITENTE

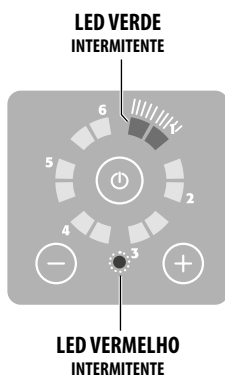

ALARM 1 = Funcionamento em seco. Ativa-se depois de 7 segundos de falta de água na aspiração. Controlar a presença de água em aspiração e encher a bomba. O DG PED efetua tentativas automáticas de re-partida após 1 min, 15 min, 30 min, 1 h, 1 h, etc.

ALARM 2 = A bomba não alcança a pressão programada. Contatar um centro de assistência.

ALARM 3 = A pressão de pré-carga do vaso é baixa demais; encher o vaso a 50% da pressão de trabalho (por ex., se o trabalho for a 3 bar, encher o vaso a 1,5 bar).

ALARM 4 = Pressão na compressão inferior a 0,2 bar (tubo partido). O rearme só pode ser manual. Verificar porque a pressão chegou a zero.

ALARM 5 = Voltagem de alimentação baixo demais.
Garantir 230V +/- 10% em alimentação.

ALARM 6 = Sinal de OFF do exterior.

LED VERDE FIXO + LED VERMELHO INTERMITENTE

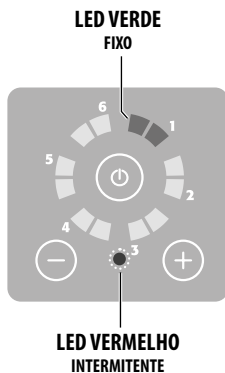

ALARM 1 = Curto-circuito. Desligar o dispositivo e contatar um centro de Assistência. O rearme só pode ser manual.

ALARM 2 = Corrente excessiva. A corrente absorvida ultrapassa a tolerância permitida. O rearme só pode ser manual. Se o problema persistir, contatar um centro de assistência.

ALARM 3 = Temperatura excessiva do módulo. Verifique a temperatura do líquido bombeado. Se o líquido não tiver uma temperatura superior a 40 °C contacte um centro de assistência. Rearme automático se a temperatura descer abaixo do valor de alarme.

ALARM 4 = Temperatura excessiva do motor. Controlar a temperatura do líquido bombeado. Se o líquido não tiver uma temperatura superior a 40 °C, contatar um centro de assistência. Rearme automático se a temperatura descer abaixo do valor de alarme.

ALARM 5 = Sinal do sensor de pressão não válido. Contatar um centro de assistência.

ALARM 6 = Sinal do sensor de fluxo não válido. Contatar um centro de assistência.

Exemplo:
bomba em alarme por FUNCIONAMENTO EM SECO
LED 1 INTERMITENTE
+
LED VERMELHO INTERMITENTE =
FUNCIONAMENTO EM SECO

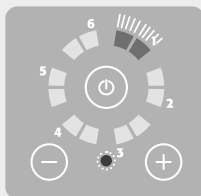

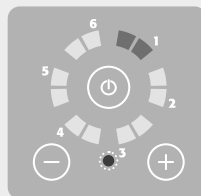

Exemplo:
bomba em alarme por CURTO-CIRCUITO

LED 1 FIXO
+
LED VERMELHO INTERMITENTE =
CURTO-CIRCUITO



PROCURA DAS AVARIAS

PROBLEMA	SINALIZAÇÃO LED	INTERVENÇÃO
O teclado não se liga.	LEDs apagados.	Verificar se o interruptor lateral está na posição "I".
		 Verificar que haja corrente na rede elétrica, verificar que o interruptor diferencial seja adequado.
A bomba não arranca ao se ativar um ponto de utilização.	LED vermelho aceso fixo.	Accionar a bomba premindo a tecla "I/O".
	LED vermelho aceso intermitente.	Ver a lista dos alarmes nas páginas anteriores.
	LED verde aceso FIXO.	A pressão do sistema não desce abaixo da pressão de trabalho programada.
Alarme de FUNCIONAMENTO EM SECO.	LED vermelho intermitente, LEDs verdes em pos. 1 intermitentes.	Verificar que haja água em aspiração. Verificar que a aspiração não esteja obstruída. Encher e escorvar a bomba.
Alarme de CURTO-CIRCUITO.	LED vermelho intermitente, LEDs verdes em pos. 1 fixos.	 Verificar que a bomba não esteja bloqueada abrindo o tampão traseiro do motor e rodando o veio.
		 Verificar a integridade de cabo, ficha e tomada e que não haja dispersões.
Alarme de TENSÃO BAIXA.	LED vermelho intermitente, LEDs verdes em pos. 5 intermitentes.	A tensão é inferior ao valor nominal de placa de mais de 10%; estabilizar a tensão para a manter nos limites +/- 10%.
A bomba para e reinicia continuamente	LED em funcionamento normal	Verifique se a pressão de enchimento do vaso está correta. Procure e elimine as fugas na instalação.

MANUTENÇÃO (só para pessoal qualificado)

INSPEÇÃO E LIMPEZA DA VÁLVULA DE RETENÇÃO DE RETENÇÃO

A VÁLVULA DE NÃO RETORNO está localizada dentro da boca de aspiração.

Para sua manutenção:

- 1 Elimine a pressão do sistema.
- 2 Remova a tampa e a forquilha (A).
- 3 Remova o cotovelo (B).
- 4 Remova a VÁLVULA DE RETENÇÃO (C).
- 5 Inspeccione/limpe a VÁLVULA DE RETENÇÃO (C).
- 6 Remonte corretamente a VÁLVULA DE RETENÇÃO (C) em seu assento.
- 7 Remonte corretamente o cotovelo (B), o garfo e a tampa (A).

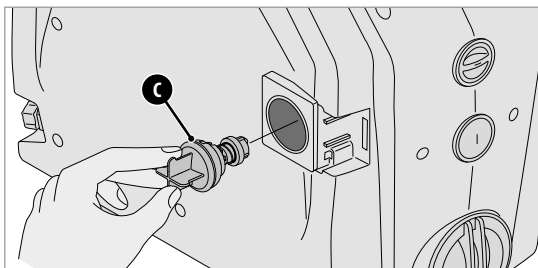
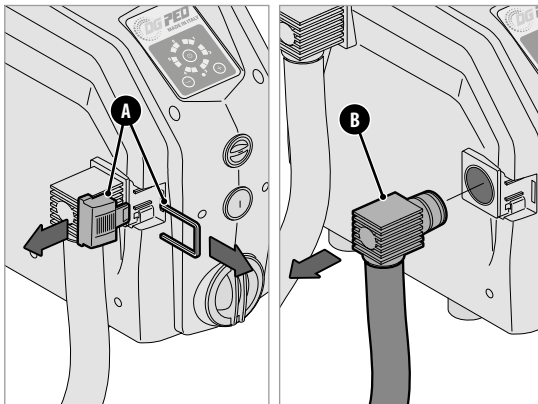

INSPEÇÃO E LIMPEZA DA VÁLVULA DE FLUXO

- 1 Depois de aliviada a pressão na instalação, despertar e remover o BUJÃO DE ENCHIMENTO (D).
- 2 Remover o grupo da VÁLVULA DE FLUXO (E) despertando o parafuso de fixação. Inspeccionar / limpar o grupo.
- 3 Montar o grupo da VÁLVULA DE FLUXO (E). Prestar atenção para orientar corretamente o grupo! Aparafuse o parafuso de fixação.
- 4 Atarraxar corretamente o BUJÃO DE ENCHIMENTO (D).

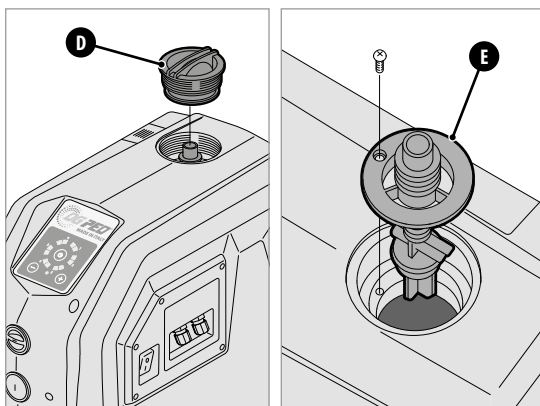

DIMENSÕES (mm)

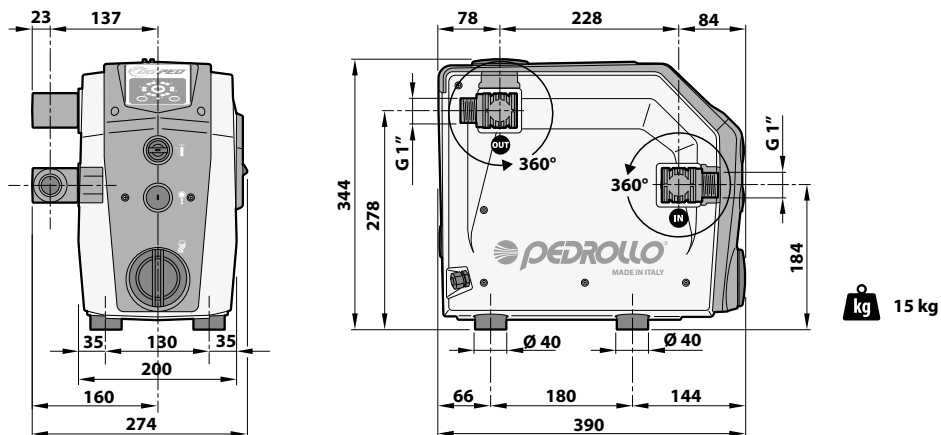

GARANTIA

Antes de instalar e utilizar o produto, ler com atenção o presente manual em todas as suas partes. A instalação e a manutenção devem ser executadas por pessoal qualificado, responsável pela realização das ligações elétricas em conformidade com as respetivas normas em vigor.

O fabricante não pode ser responsabilizado por danos derivados de uma utilização inadequada do produto e não é responsável por danos causados por manutenções ou reparações efetuadas por pessoal não qualificado e/ou com peças de reposição não de origem. A utilização de peças de reposição não de origem, modificações ou utilizações inadequadas anulam a garantia do produto.

ELIMINAÇÃO

Para a eliminação das peças que compõem o DG PED cumprir as normas e as leis em vigor nos países em que o grupo for utilizado.

Não dispersar no ambiente partes que o possam poluir.



**Eliminação correta dos REEE
(DIRETIVA 2012/19/UE)**

DECLARAÇÃO DE CONFORMIDADE



Declaramos, sob nossa exclusiva responsabilidade, que o produto em questão resulta em conformidade com o previsto pelas seguintes Diretivas Comunitárias, inclusive as últimas alterações, e com as respetivas leis nacionais de acolhimento:

2006/42/EU, 2014/35/EU, 2014/30/EU, 2009/125/EU, 547/2012/EU, 2011/65/EU, 2015/863/EU, 1907/2006/EU, 2012/19/UE

San Bonifacio, 25/02/2022

Pedrollo S.p.A.

O Presidente

Silvano Pedrollo

СОДЕРЖАНИЕ

ОБЩАЯ ИНФОРМАЦИЯ.....	89
НОРМЫ БЕЗОПАСНОСТИ	89
ОПИСАНИЕ ИЗДЕЛИЯ.....	90
ТЕХНИЧЕСКИЕ ДАННЫЕ	91
ОГРАНИЧЕНИЯ В ПРИМЕНЕНИИ	91
ГРАФИКИ ПРОИЗВОДИТЕЛЬНОСТИ	91
СВЕТОВЫЕ СИГНАЛЫ	92
УСТАНОВКА И ГИДРАВЛИЧЕСКИЕ СОЕДИНЕНИЯ	92
ЗАПОЛНЕНИЕ И ВКЛЮЧЕНИЕ	94
РЕГУЛИРОВКА РАБОЧЕГО ДАВЛЕНИЯ.....	96
НАКАЧИВАНИЕ БАЧКА	96
ВЫБОР ФУНКЦИИ САМОЗАЛИВКИ	97
ЭЛЕКТРИЧЕСКИЕ СОЕДИНЕНИЯ ПЛАТА РАСШИРЕНИЯ	97
АВАРИЙНЫЕ СИГНАЛЫ	98
ПОИСК НЕИСПРАВНОСТЕЙ	99
ТЕХОБСЛУЖИВАНИЕ.....	100
РАЗМЕРЫ.....	101
ГАРАНТИЯ	101
УТИЛИЗАЦИЯ.....	101
ДЕКЛАРАЦИЯ СООТВЕТСТВИЯ.....	101

ОБЩАЯ ИНФОРМАЦИЯ

Оригинальная инструкция по эксплуатации.

Настоящее руководство должно всегда прилагаться к описанному в нем прибору и храниться в доступном месте для возможности его использования персоналом, занимающимся эксплуатацией и техобслуживанием системы. Просим установщика/пользователя внимательно ознакомиться с содержащимися в настоящем руководстве предписаниями и информацией до начала эксплуатации прибора, во избежание его порчи, неправильного использования или отмены гарантии. Запрещается эксплуатация прибора детьми или лицами с ограниченными физическими, сенсорными или умственными возможностями, а также не обладающими достаточными знаниями или опытом, если они не прошли соответствующее обучение и не находятся под наблюдением. Следует следить за тем, чтобы дети не играли с прибором. Компания-производитель снимает с себя всякую ответственность за ущерб или несчастный случай, произошедший в результате халатности или несоблюдения описанных в настоящем руководстве инструкций, а также в случае эксплуатации прибора в условиях, которые не соответствуют указанным на его табличке параметрам. Кроме того, она снимает с себя ответственность за ущерб, нанесенный в результате ненадлежащей эксплуатации электронасоса. Запрещается ставить на упаковку грузы или другие коробки.

НОРМЫ БЕЗОПАСНОСТИ

В настоящем руководстве были использованы символы, которые имеют следующее значение.



Данный символ предупреждает о том, что несоблюдение указания влечет за собой риск поражения электрическим током.



Данный символ предупреждает о том, что несоблюдение указания влечет за собой риск нанесения ущерба вещам или людям.



До начала установки и эксплуатации изделия:

- Внимательно полностью прочитайте настоящее руководство.
- Проверьте, чтобы указанные на паспортной табличке данные соответствовали необходимым и предусмотренным для вашей установки параметрам.
- Установка и техобслуживание должны выполняться квалифицированным персоналом, ответственным за подключение к электросети согласно действующим

местным нормам;

- Производитель снимает с себя всякую ответственность за ущерб, нанесенный в результате ненадлежащей эксплуатации изделия, а также не несет ответственности за ущерб, нанесенный в результате техобслуживания или ремонта, выполненного неквалифицированным персоналом и/или с использованием неоригинальных запчастей.
- Использование неоригинальных запчастей, нарушение целостности прибора или его ненадлежащая эксплуатация приведут к отмене гарантии на изделие.



В случае первой установки и техобслуживания удостоверьтесь в том, что:

- Отключено напряжение в электросети.
- Сеть питания оснащена защитными устройствами, в частности, высокочувствительным дифференциальным выключателем (30 мА класса А), пригодным для защиты от тока с боя переменного, однополюсного пульсирующего, постоянного и высокочастотного типа. Удостоверьтесь также, что заземление соответствует действующим нормативам.
- Прежде чем снять с инвертора крышку или приступить к его осмотру, необходимо отключить установку от сети питания и обождать 5 минут разгрузки конденсаторов через встроенные разгрузочные резисторы.



ВНИМАНИЕ: в режиме выхода из строя (при мигающем красном индикаторе) DG PED остается под напряжением; до начала проведения любых операций с насосом или инвертором, обязательно отключите напряжение всего блока.



Аварийная остановка

- Во время работы DG PED можно выполнить аварийную остановку, нажав на кнопку I/OO.
- При параллельной работе двух устройств систему блокирует только ведущий инвертор MASTER.



На этапе первого монтажа и техобслуживания, проверьте ОТСУТСТВИЕ НАПРЯЖЕНИЯ в электросети



На этапе первого монтажа и техобслуживания, проверьте ОТСУТСТВИЕ ДАВЛЕНИЯ в установке



ЗАПРЕЩАЕТСЯ ОТКРЫВАТЬ КРЫШКИ ИНВЕРТОРА, кроме крышки разъемов

ОПИСАНИЕ ИЗДЕЛИЯ

DG PED является автоматической системой герметизации с инвертором, которая включает в себя высокоэффективный самозаливной электронасос, вместительный накопительный бак, датчики давления и потока, невозвратный клапан.

Речь идет об очень компактной, бесшумной и высокопроизводительной насосной системе.

Сверхсовременное электронное управление посредством инвертора интуитивно и разумно контролирует всю систему:

- давление в установке поддерживается на постоянном уровне за счет регулировки скорости работы насоса в зависимости от потребностей в воде;
- контролируются гидравлические и электрические рабочие параметры, защищая электронасос от поломок;
- система может быть оснащена расширительным модулем, позволяющим работать параллельно с другими инверторами насосных установок и управлять сигналами на входе и выходе;
- система подходит для работы с герметизирующим оборудованием любого типа, в том числе с уже суще-

ствующими установками. Аппарат пригоден для применения в водопроводной сети, если это допускается действующими нормами. В этом случае необходимо установить перед ним невозвратный клапан;

- ограничивает значения пускового и рабочего тока, обеспечивая тем самым улучшение экономии электроэнергии.

При параллельной работе различаются ведущий инвертор **MASTER** и контролируемые инвертором **MASTER** ведомые инверторы **SLAVE**.

MASTER задает программирование параметров и контролирует рабочие значения, а также по необходимости включает и отключает инверторы **SLAVE**.



При отключении инвертора **MASTER** инверторы **SLAVE** становятся самостоятельными и возвращаются к независимому режиму работы.

При параллельной работе с другими инверторами, **DG PED** управляет чередованием запусков с целью достижения равномерной эксплуатации всех насосов.

ПЕРЕЧЕНЬ КОМПОНЕНТОВ

1. Главный выключатель I/O
2. Уплотнители сигнальных проводов ВВОДОВ/ВЫВОДОВ
3. Панель управления
4. Заливная пробка
5. Пробка расширительного бачка
6. Выпускная пробка
7. Сливная пробка
8. Плата расширения
9. Предохранитель 12,5 А (быстрого срабатывания)
10. Вилка для блокировки соединителя
11. Поворотное колено с уплотнительным кольцом
12. Напорный патрубок
13. Всасывающий патрубок
14. Антивибрационные ножки
15. Шнур питания

ПАНЕЛЬ УПРАВЛЕНИЯ

16. Кнопка включения/выключения 
17. Зеленые светодиоды для индикации:
 - работы насоса;
 - рабочего давления;
 - аварийных сигналов
18. Светодиоды зеленого или красного цвета
19. Кнопки  и  для увеличения или уменьшения значений.

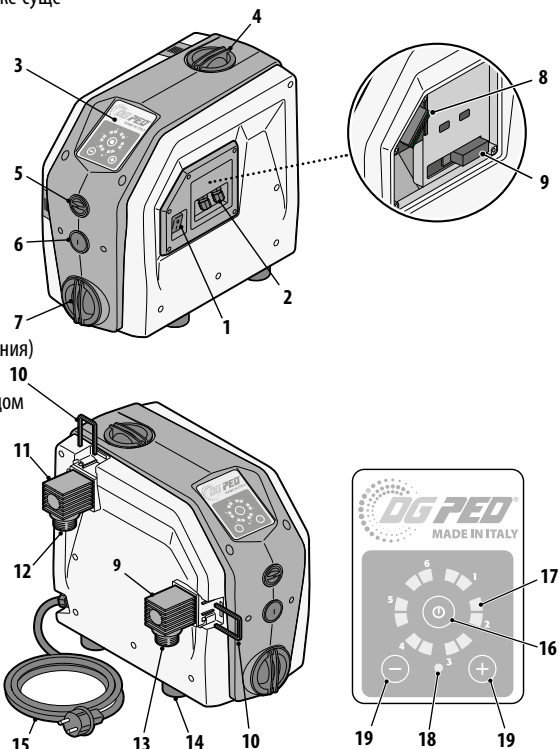

ТЕХНИЧЕСКИЕ ДАННЫЕ

- Напряжение питания ~ **230 V** ± 10%
- Частота **50/60 Hz**
- Изоляция: **класс F**
- Максимальный потребляемый ток
 - **7.5 A** DG PED 3
 - **10 A** DG PED 5
- P1 Максимальная потребляемая мощность:
 - **1.0 kW** DG PED 3
 - **1.5 kW** DG PED 5
- Защита **IP X4**
- Заводская установка **3 бар**
- Предохранитель **12,5 А** (быстрого срабатывания)

ОГРАНИЧЕНИЯ В ПРИМЕНЕНИИ

- Высота отсасывания по манометру – до **8 м**
- Температура жидкости от **0 °С** до **+40 °С**
- Температура окружающей среды от **0 °С** до **+40 °С**
- Макс.давление **10 бар**
- Постоянная работа **S1**
- Рабочее положение вертикальное



ЧИСТАЯ ВОДА



ПРИМЕНЕНИЕ В БЫТУ



ПРИМЕНЕНИЕ В ХОЗЯЙСТВЕ

ГРАФИКИ ПРОИЗВОДИТЕЛЬНОСТИ

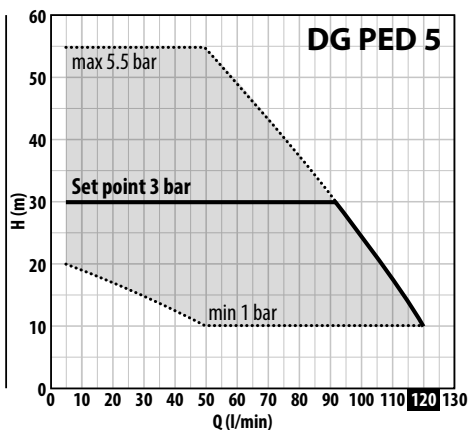
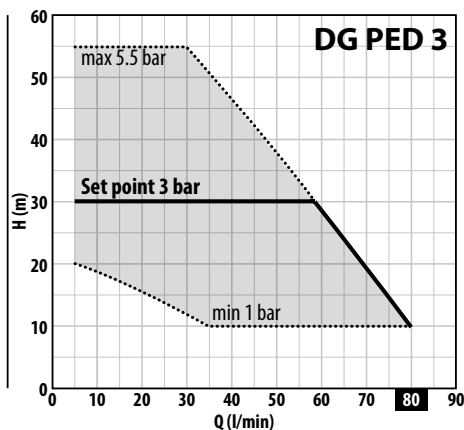

ТИП	МОЩНОСТЬ		▲	МАКС. ПРОИЗВОДИТЕЛЬНОСТЬ		ПРОИЗВОДИТЕЛЬНОСТЬ (РЕГУЛИРУЕМАЯ УСТАВКА)					
	P2 kW	HP		Q л/мин	H метров	Мин.установка бар		Станд.установка бар		Макс.установка бар	
Однофазный			IE3	л/мин	метров	бар	л/мин	бар	л/мин	бар	л/мин
DG PED 3	0.75	1		5 – 80	55 – 10	1	35 – 80	3	5 – 58	5.5	5 – 30
DG PED 5	1.1	1.5		5 – 120	55 – 10	1	50 – 120	3	5 – 92	5.5	5 – 50

Q = Расход H = Общий манометрический напор

▲ Класс КПД трехфазного двигателя (IEC 60034-30-1)

Допуск кривых производительности согласно EN ISO 9906 Коэффициент 3В.

Указанные характеристики касаются напора на всасывании, равном -1 м (всасывание 1 м). Если уровень воды на всасывании ниже высоты отверстия насоса, показатели снизятся соответствующим образом.

СВЕТОВЫЕ СИГНАЛЫ

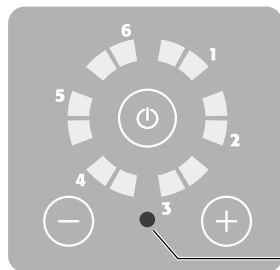

КРАСНЫЙ
СВЕТОДИОД

НЕ РАБОТАЕТ

DG PED под напряжением, но не работает

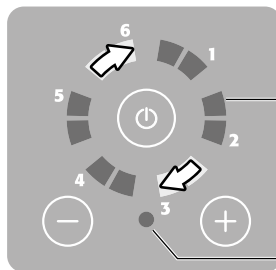

ЗЕЛЕНЫЕ
СВЕТОДИОДЫ
РЕЖИМ ЦИРКУЛЯЦИИ

ЗЕЛЕНый
СВЕТОДИОД

НАСОС РАБОТАЕТ

DG PED под напряжением и насос работает

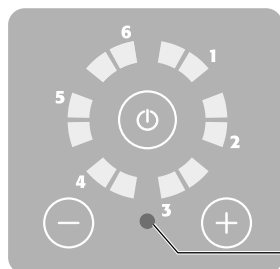

ЗЕЛЕНый
СВЕТОДИОД

ОЖИДАНИЕ

DG PED под напряжением, но насос не работает

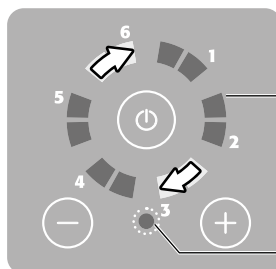

ЗЕЛЕНЫЕ
СВЕТОДИОДЫ
РЕЖИМ ЦИРКУЛЯЦИИ

ЗЕЛЕНый
СВЕТОДИОД
МИГАЕТ

НАСОС В ПРОЦЕССЕ ОСТАНОВКИ

DG PED под напряжением и насос в процессе остановки

УСТАНОВКА И ГИДРАВЛИЧЕСКИЕ СОЕДИНЕНИЯ

(только для квалифицированного персонала)



На этапе начальной установки и техобслуживания убедитесь в **ОТСУТСТВИИ НАПЯЖЕНИЯ** в электросети



На этапе начальной установки и техобслуживания убедитесь в **ОТСУТСТВИИ ДАВЛЕНИЯ** в установке

Удостоверьтесь в том, что электросеть надлежащим образом защищена и, в частности, на ней установлены соответствующие действующим нормативам высокочувствительный дифференциальный выключатель (30 mA in classe A) idoneo a proteggere da correnti di guasto di tipo alternato, unipolare pulsante, continuo, ad alta frequenza. Verificare inoltre che la messa a terra sia conforme alle norme.

Проверьте соответствие указанных на табличке данных параметрам установки.

Установите DG PED в помещении:

- защищенном от воздействия внешних атмосферных факторов;
- хорошо проветриваемом, достаточно сухом и защищенном от пыли;
- защищенном от вредной вибрации или механических усилий подсоединенных труб.

- 1 Отрегулируйте ножки, чтобы соответствующим образом выровнять DG PED

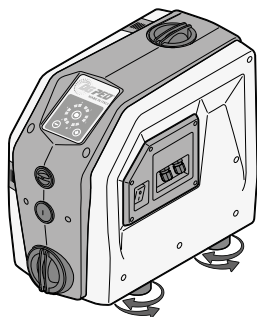

- 2 Снимите заглушки с вилок

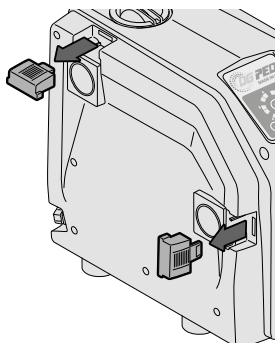

- 3 Снимите вилки

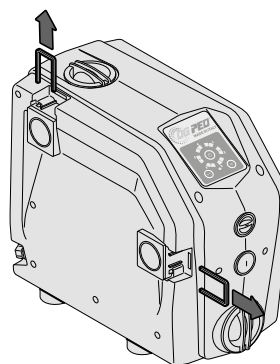

- 4 Вставьте колена с уплотнительными кольцами

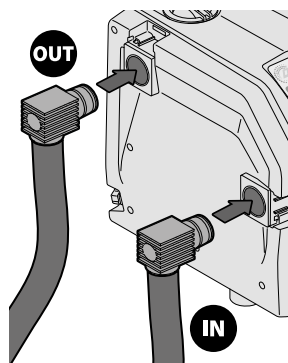

 Минимальный диаметр всасывающей трубы должен составлять 1" и она должна быть полностью герметизирована

- 5 Правильно установите вилки

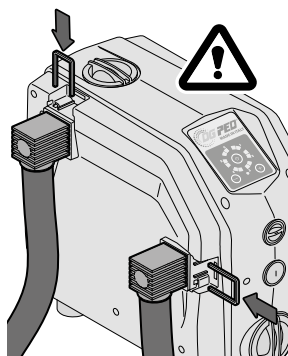

- 6 Установите заглушки вилок

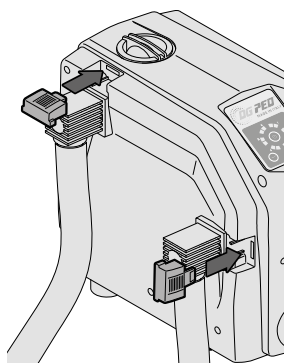

 К установке можно добавить расширительный бак, установив его со стороны напора (OUT).

ЗАПОЛНЕНИЕ И ВКЛЮЧЕНИЕ (только для квалифицированного персонала)

 DG PED не должен работать всухую во избежание повреждения механического уплотнения.

СЛУЧАЙ А: работа «ПОД ЗАЛИВ» (цистерна или водопровод)

1 Откройте все клапаны для заполнения насоса водой.

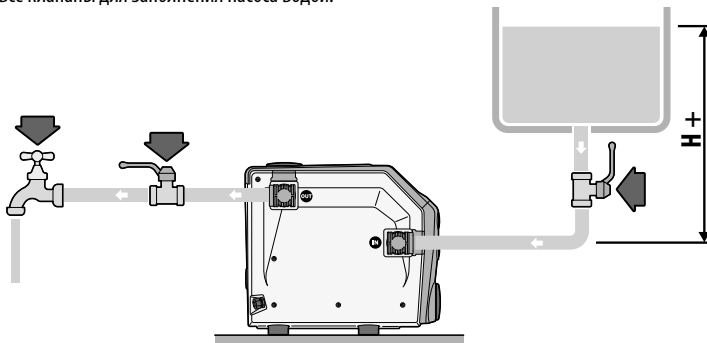

2 Подсоедините его к электросети.

3 Установите выключатель в положении "I".

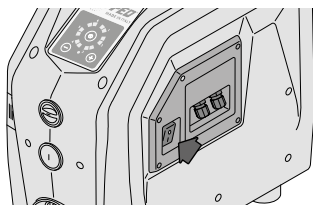

4 Нажмите кнопку  для запуска DG PED.



СЛУЧАЙ Б: работа ВЫШЕ УРОВНЯ ВОДЫ (выкачивание из ванны или колодца)

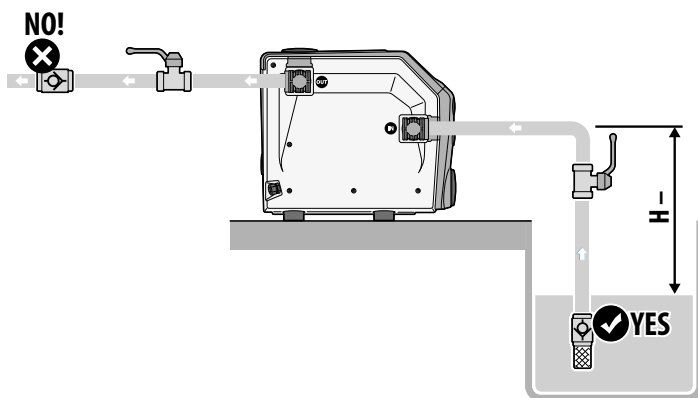

- 1 Отвинтите и снимите заливную и выпускную пробки.
- 2 Залейте около 1,5 литров воды до ее выхода из выпускного отверстия.
- 3 Закрутите заливную и выпускную пробки.
- 4 Откройте кран с водой.
- 5 Вставьте вилку в розетку электросети.
- 6 Установите выключатель в положении "I".

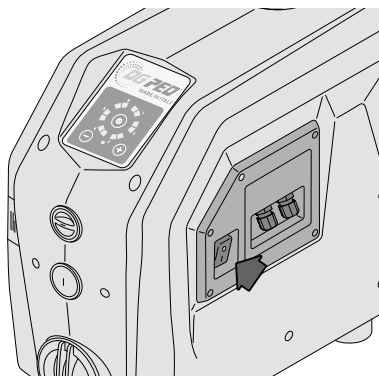
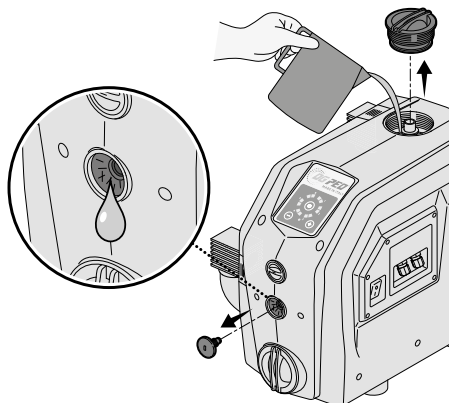

- 7 ОДНОВРЕМЕННО держите нажатыми кнопки ⊕ и ⊖ в течение 5 секунд. DG PED войдет в режим заливки.

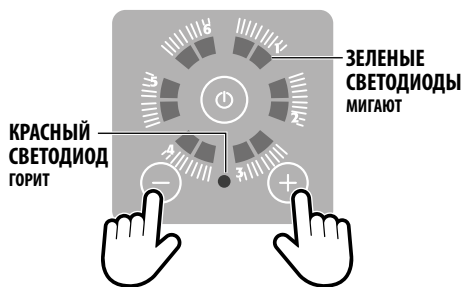

- 8 Нажмите кнопку ⏻ для начала заливки.

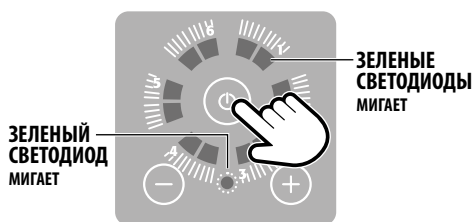

Процедура заливки длится не более 5 минут. По истечении каждой минуты DG PED автоматически останавливает электронасос на 5 секунд и перезапускает его по истечении этого периода. Этот процесс продолжается до тех пор, пока происходит заливка DG PED. Во время этой процедуры светодиоды продолжают мигать.

Выход из процедуры заливки происходит или по истечении времени (через 5 минут) или по окончании заливки. Светодиоды прекратят мигать. Если насос не будет залит, повторите операцию с самого начала.

РЕГУЛИРОВКА РАБОЧЕГО ДАВЛЕНИЯ

РАБОЧЕЕ ДАВЛЕНИЕ показывается с помощью загорающихся на панели управления светодиодов зеленого цвета.

Диапазон РАБОЧЕГО ДАВЛЕНИЯ DG PED составляет от минимум 1 бар до максимум 5,5 бар.

Для регулировки:

- Нажмите кнопку **+** для визуализации РАБОЧЕГО ДАВЛЕНИЯ.
- Нажмите кнопки **+** или **-** для увеличения или уменьшения РАБОЧЕГО ДАВЛЕНИЯ. При каждом нажатии на кнопку **+** или **-** значение увеличивается или уменьшается на 0,5 бар.

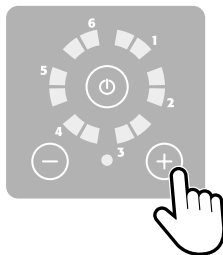

Пример

Нажмите кнопку **+** для визуализации РАБОЧЕГО ДАВЛЕНИЯ

При горящих зеленых светодиодах, как показано на рисунке, рабочее давление составляет **2 бар**

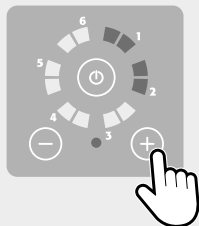

Для увеличения рабочего давления, например, до 3 бар, нажмите на кнопку **+** дважды.

Значение возрастет на 1 бар (0,5+0,5 бар)

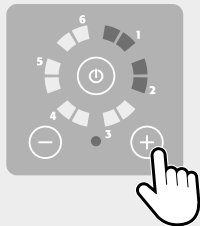

Светодиоды загорятся, как показано на рисунке. Рабочее давление составляет **3 бар**.



НАКАЧИВАНИЕ БАЧКА

(только для квалифицированного персонала)

Заводское значение давления расширительного бачка внутри DG PED составляет 1,5 бар.

Оптимальное накачивание бачка гарантирует бесперебойную работу системы и предотвращает преждевременный разрыв мембраны.

⚠️ Накачивание бачка должно осуществляться при отсутствии давления в установке. Максимальное давление накачивания составляет 4 бар.

⚠️ Накачивайте воздух в расширительный бак в соответствии с таблицей. При значении рабочего давления ниже 3 бар начальное давление воздуха в баке должно быть меньше его на 0,5 бар. Например: рабочее давление = 2 бар, давление накачки = 1,5 бар

Для накачивания расширительного бачка:

- Снимите пробку.
- Установите компрессор
- Подсоедините трубку компрессора к напорному клапану
- Накачайте расширительный бачок до необходимого давления

⚠️ Проверяйте начальное давление воздуха в баке не реже одного раза в год. При необходимости отрегулируйте его.

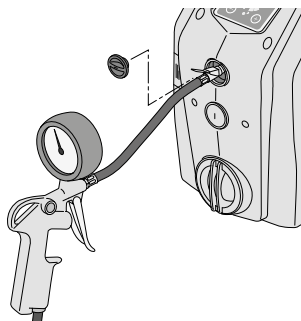

Рабочее давление	Давление накачивания
3.0 bar	1.5 bar
3.5 bar	2.0 bar
4.0 bar	2.5 bar
4.5 bar	3.0 bar
5.0 bar	3.5 bar
5.5 bar	4.0 bar

ВЫБОР ФУНКЦИИ САМОЗАЛИВКИ (только для квалифицированного персонала)

Насос выпускается с производства в версии САМОЗАЛИВКИ; в случае гарантированной работы под заливом или питания под давлением, можно отключить функцию самозаливки, установив показанный рычаг в вертикальное положение.

- 1 Отвинтите и снимите сливную пробку. Возможный выход воды.

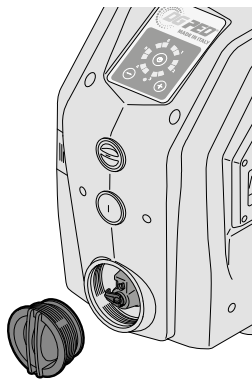

- 2 Поверните красный рычажок в вертикальное положение для отключения функции самозаливки.

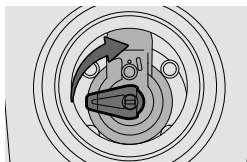

САМОЗАЛИВКА
(заводская установка)

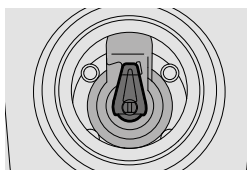

БЕЗ САМОЗАЛИВКИ

- 3 Установите на место сливную пробку. Вновь залейте DG PED водой, как указано в разделе ЗАПОЛНЕНИЕ И ВКЛЮЧЕНИЕ.

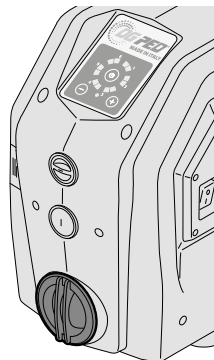

ЭЛЕКТРИЧЕСКИЕ СОЕДИНЕНИЯ ПЛАТА РАСШИРЕНИЯ

(только для квалифицированного персонала)



Удостоверьтесь в **ОТСУТСТВИИ НАПРЯЖЕНИЯ** в электричестве.

ВНИМАНИЕ: любое устройство, подключенное к плате расширения, должно находиться под очень низким допустимым напряжением (SELV).



При снятии крышки не тяните за подсоединенные к главному выключателю электропровода.

- Отвинтите и снимите крепежные винты крышки.
- Частично снимите крышку для получения доступа к клеммной коробке платы расширения.

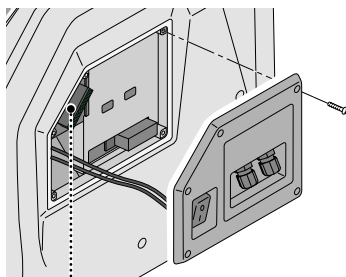

ОБОЗНАЧЕНИЯ КЛЕММНОЙ КОРОБКИ

- 1-2 INPUT СИГНАЛ УРОВНЯ – переключение при отсутствии сигнала
- 3-4 OUTPUT АВАРИЙНЫЙ СИГНАЛ – макс. 0,3 А @ 230 пер.тока / 1А @ 30 пост.тока
- 5-6 RS 485 связь MASTER / SLAVE
- 7-8 0V не подсоединен
- 9-10 SLAVE при переключении инвертор становится SLAVE

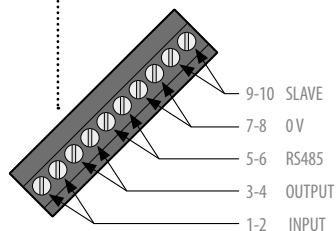

АВАРИЙНЫЕ СИГНАЛЫ

МИГАЮЩИЙ ЗЕЛЕНЬЙ СВЕТОДИОД + МИГАЮЩИЙ КРАСНЫЙ СВЕТОДИОД

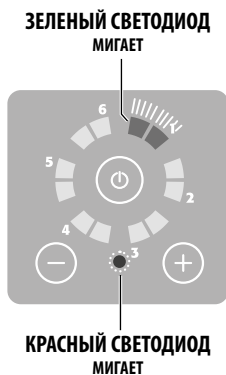

- ALARM 1** = Работа всухую. Срабатывает спустя 7 сек. отсутствия воды на всасывании. Проверьте наличие воды на входе и заполните насос. DG PED осуществляет автоматические попытки перезапуска через 1 мин., 15 мин., 30 мин., 1 ч, 1 ч, и т.д.
- ALARM 2** = Насос не достигает установленного давления. Свяжитесь со службой технической поддержки.
- ALARM 3** = Слишком низкое давление предварительной загрузки бачка; накачайте бачок до 50% рабочего давления (например, при рабочем давлении 3 бар, накачайте бачок до 1,5 бар).
- ALARM 4** = Напорное давление составляет менее 0,2 бар (неисправность трубы). Только ручной сброс. Проверьте причину обнуления давления.
- ALARM 5** = Слишком низкое напряжение питания. Обеспечьте питание 230В +/- 10%.
- ALARM 6** = Внешний сигнал OFF.

ЗЕЛЕНЬЙ СВЕТОДИОД ПОСТОЯННО ГОРИТ + КРАСНЫЙ СВЕТОДИОД МИГАЕТ

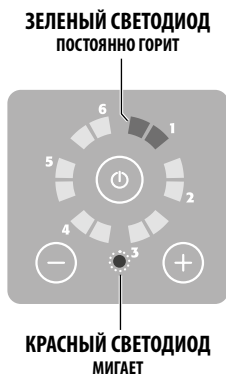

- ALARM 1** = Короткое замыкание. Выключите устройство и свяжитесь со службой технической поддержки. Только ручное восстановление.
- ALARM 2** = Сверхток. Поглощенный ток превысил допустимый предел. Только ручное восстановление. Если проблема не будет решена, свяжитесь со службой технической поддержки.
- ALARM 3** = Перегрев модуля. Проверьте температуру перекачиваемой жидкости. Если температура жидкости не превышает 40 °С, обратитесь в сервисный центр. Автоматическое восстановление, если температура опустится ниже аварийного уровня.
- ALARM 4** = Перегрев двигателя. Проверьте температуру перекачиваемой жидкости. Если температура жидкости не достигнет 40°С, свяжитесь со службой технической поддержки. Автоматическое восстановление, если температура опустится ниже аварийного уровня.
- ALARM 5** = Недействительный сигнал датчика давления. Свяжитесь со службой технической поддержки.
- ALARM 6** = Недействительный сигнал датчика потока. Свяжитесь со службой технической поддержки.

Пример:
авария насоса из-за
РАБОТЫ ВСУХУЮ

СВЕТОДИОД 1 МИГАЕТ
+
КРАСНЫЙ СВЕТОДИОД
МИГАЕТ
=
РАБОТА ВСУХУЮ

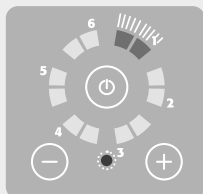

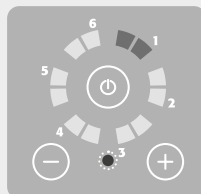

Пример:
авария насоса из-за
КОРОТКОГО ЗАМЫКАНИЯ

СВЕТОДИОД 1 ПОСТОЯННО
ГОРИТ
+
КРАСНЫЙ СВЕТОДИОД
МИГАЕТ
=
КОРОТКОЕ ЗАМЫКАНИЕ



ПОИСК НЕИСПРАВНОСТЕЙ

ПРОБЛЕМА	СИГНАЛ СВЕТОДИОДА	РЕШЕНИЕ
Не включается кнопочная панель	Светодиоды отключены	Удостоверьтесь, что боковой выключатель находится в положении "I".
		 Проверьте наличие электропитания в сети, проверьте пригодность дифференциального выключателя.
Насос не запускается при открытии потребителя	Красный светодиод постоянно горит.	Включите насос, нажав кнопку "I/O".
	Красный светодиод мигает.	Просмотрите перечень аварийных сигналов на предыдущих страницах.
	Зеленый светодиод постоянно горит.	Давление в установке не уменьшается ниже установленного рабочего давления.
Аварийный сигнал РАБОТЫ ВСУХУЮ	Красный светодиод мигает, Зеленые светодиоды в поз. 1 мигают.	Проверьте наличие воды на всасывании Проверьте проходимость всасывающего патрубка Наполните и залейте насос.
Аварийный сигнал КОРОТКОГО ЗАМЫКАНИЯ	Красный светодиод мигает, Зеленые светодиоды в поз. 1 постоянно горят.	 Удостоверьтесь в том, что насос не заблокирован, открыв заднюю заглушку двигателя и повернув вал.
		 Проверьте отсутствие повреждений провода, вилки и розетки, а также отсутствие утечек.
Аварийный сигнал НИЗКОГО НАПЯЖЕНИЯ	Красный светодиод мигает, Зеленые светодиоды в поз. 5 мигают.	Напряжение ниже указанного на табличке значения более чем на 10%; стабилизируйте напряжение, поддерживая его в пределах +/- 10%.
Насос часто останавливается и запускается	Сигнал светодиодов соответствует исправной работе установки	Проверьте давление воздуха в баке. Проверьте герметичность системы и устраните обнаруженные протечки.

ТЕХНИЧЕСКОЕ ОБСЛУЖИВАНИЕ (только для квалифицированного персонала)

ПРОВЕРКА И ОЧИСТКА ОБРАТНОГО КЛАПАНА

ОБРАТНЫЙ КЛАПАН расположен внутри всасывающего патрубка.

Для демонтажа:

- 1 Снимите давление с системы.
- 2 Rimuovere il coperchio e la forcella (A).
- 3 Снимите локтевую муфту (B).

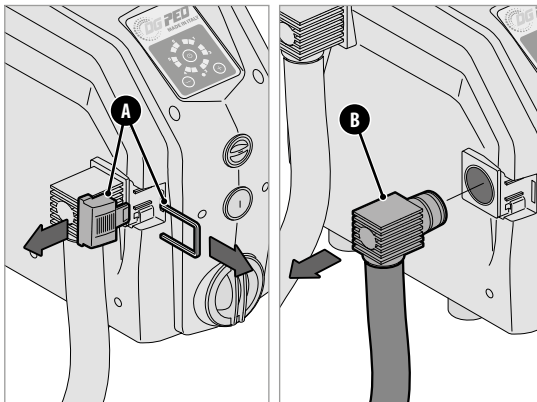

- 4 Вытащите ОБРАТНЫЙ КЛАПАН (C).
- 5 Осмотрите/очистите ОБРАТНЫЙ КЛАПАН (C).
- 6 Правильно установите ОБРАТНЫЙ КЛАПАН (C) на свое место.
- 7 Правильно установите муфту (B), вилку и крышку (A).

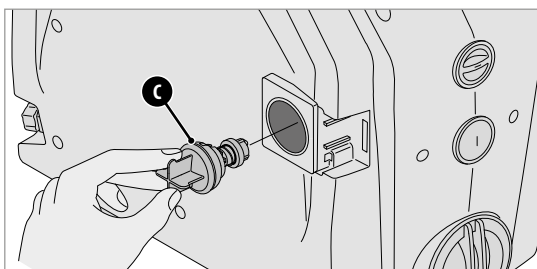

ОСМОТР И ОЧИСТКА РАСХОДНОГО КЛАПАНА

- 1 После снятия давления из системы открутите и снимите ЗАЛИВНУЮ ПРОБКУ (D).
- 2 Снимите узел КЛАПАНА ПОТОКА (E), открутив крепежный винт. Осмотрите / очистите его.
- 3 Смонтируйте КЛАПАН ПОТОКА (E). Обратите внимание на направление клапана! Закрутите фиксирующие болты.
- 4 Правильно закрутите ЗАЛИВНУЮ ПРОБКУ (D).

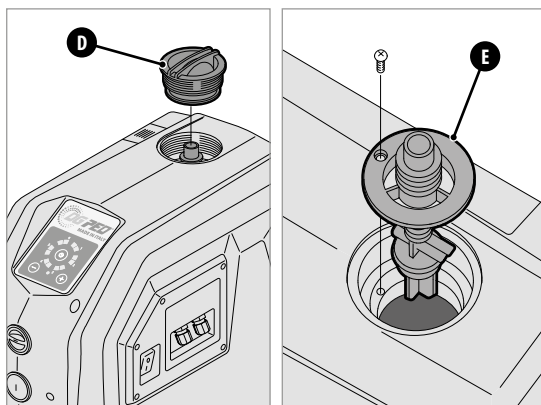

РАЗМЕРЫ (mm)

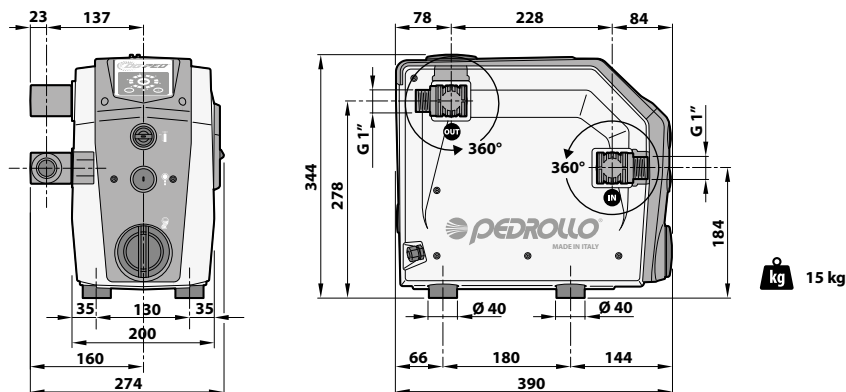

ГАРАНТИЯ

Внимательно и полностью прочитайте настоящее руководство до начала установки и эксплуатации изделия. Установкой и техобслуживанием должен заниматься квалифицированный персонал, несущий ответственность за выполнение гидравлических и электрических соединений в соответствии с применимым действующим законодательством. Производитель снимает с себя всякую ответственность за ущерб, нанесенный в результате ненадлежащей эксплуатации изделия, а также не несет ответственности за ущерб, нанесенный в результате техобслуживания или ремонта, выполненного неквалифицированным персоналом и/или с использованием неоригинальных запчастей. Использование неоригинальных запчастей, нарушение целостности прибора или его ненадлежащая эксплуатация приведут к отмене гарантии на изделие, срок которой составляет 24 месяца с момента его приобретения.

УТИЛИЗАЦИЯ

При утилизации компонентов панелей DG PED соблюдайте нормы и законы, действующие в стране использования изделия.

Не выбрасывайте загрязняющие детали в окружающую среду.



**Правильная утилизация
электрического и электронного
оборудования
(ДИРЕКТИВА 2012/19/ЕС)**

ДЕКЛАРАЦИЯ СООТВЕТСТВИЯ



Заявляем с полной ответственностью, что описанное в настоящем руководстве изделие соответствует нормам указанных ниже общеевропейских директив, включая последние внесенные в них изменения, а также соответствующему внутреннему законодательству нашей страны:

2006/42/EU, 2014/35/EU, 2014/30/EU, 2009/125/EU, 547/2012/EU, 2011/65/EU, 2015/863/EU, 1907/2006/EU, 2012/19/UE

San Bonifacio, 25/02/2022

Pedrollo S.p.A.
Il Presidente
Silvano Pedrollo

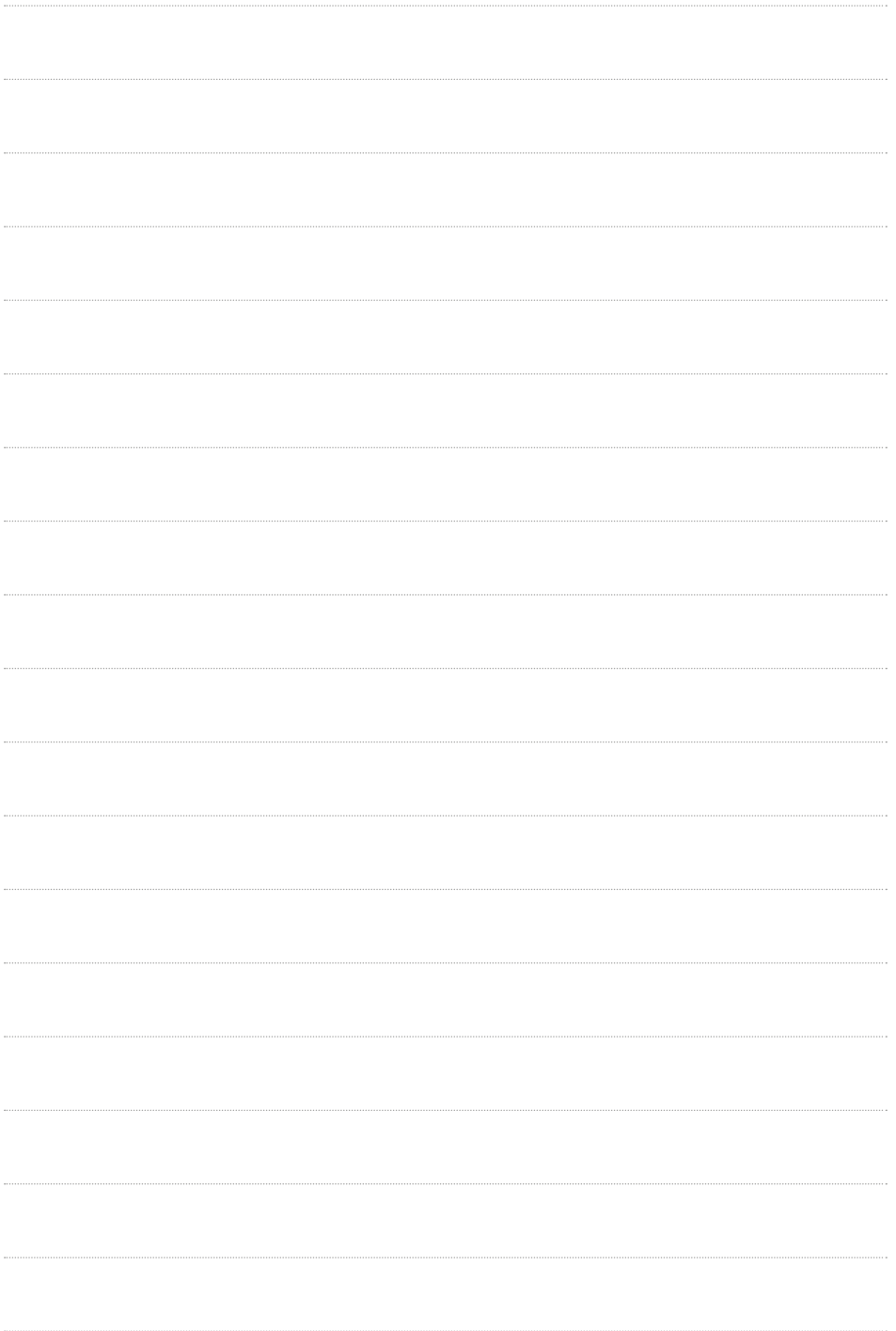

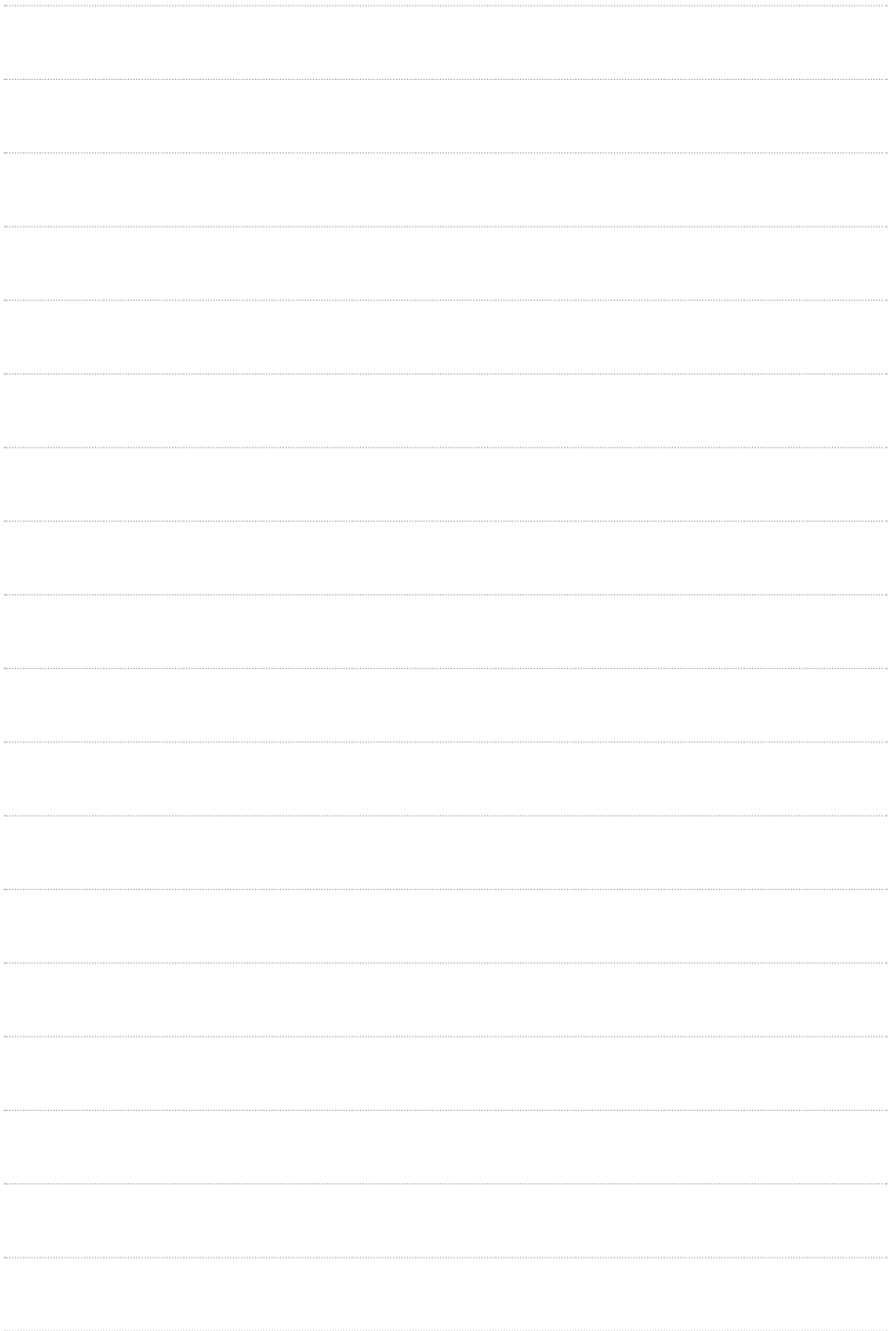



PEDROLLO S.p.A.
Via E. Fermi, 7 37047 – San Bonifacio (VR) - Italy
Tel. +39 045 6136311 – Fax +39 045 7614663
e-mail: sales@pedrollo.com – www.pedrollo.com
