

68003A

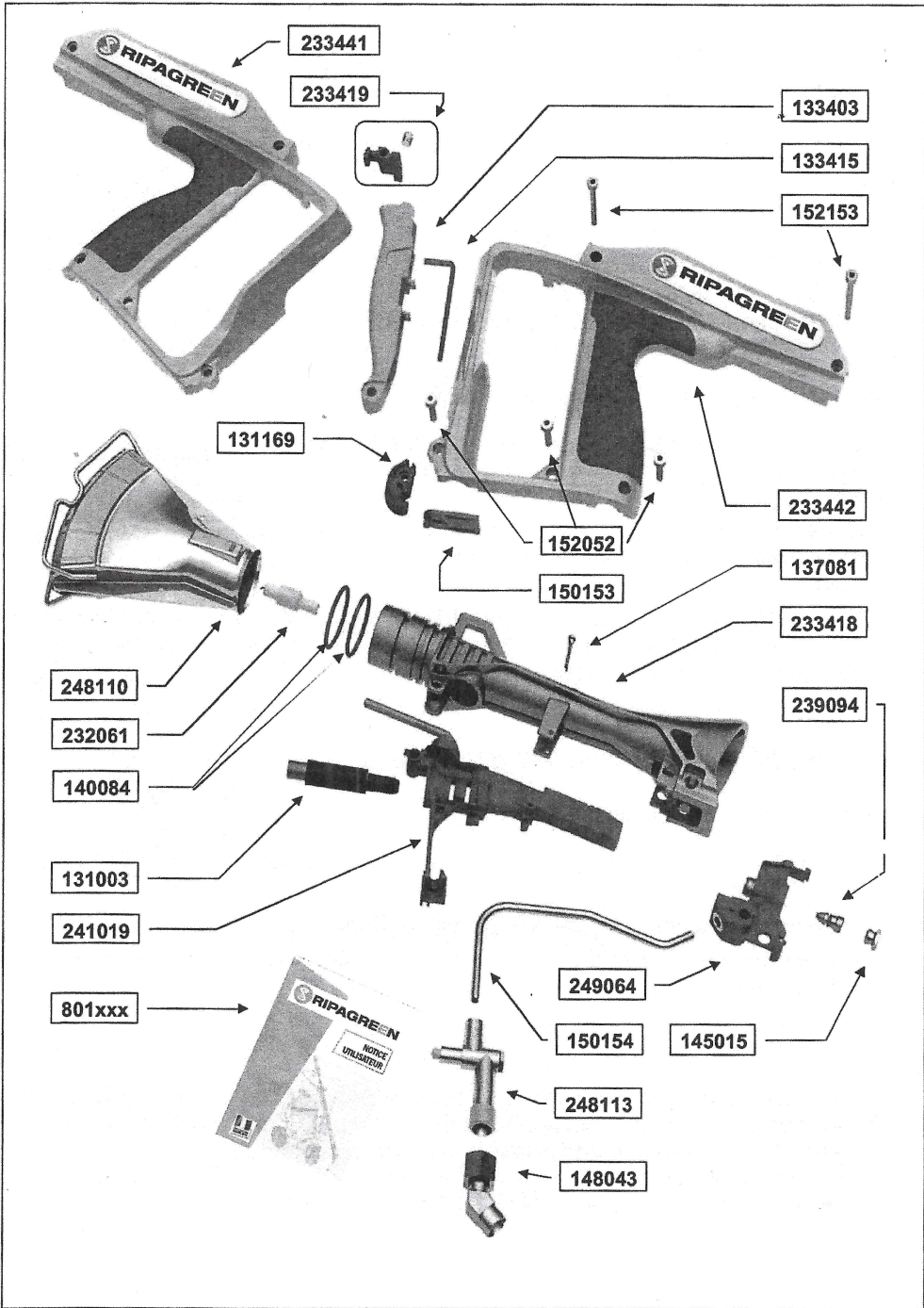

Artikel-Nr.	Bezeichnung
131003	Piezo Zünder für RIPAGREEN
131169	Bumper
133132	Kombischlüssel Schlauch-Druckregler 19 - 30
133403	Abzugshahn
133415	Inbusschlüssel 3
134024	SECURIPACK- DIN- einschließlich einstellbarem Druckregler und doppelter Sicherheit
137039	MOLYKOTE Fett
137081	Massen Stift
140020	Druckregler-Dichtung für SECURIPACK DIN
140060	O-Ring Dichtung für Verlängerungen - innen Ø 28.24 x Ø 2.62
140084	O-Ring Dichtung für Pistolenrumpf - innen Ø 34,82x3,53
145015	Düsenverschluss RIPACK SERIES 3000
148043	Drehgelenk
150153	Piezo Klappe
150154	Aluminium Gasrohr
152052	Inbus-Schraube CHc M4x16
152153	Inbus-Schraube CHc M4x35
232061	Zündkerze
233418	Pistolenrumpf mit O-Ringe
233419	Klinke + Feder
233441	Handgriffhälfte rechts + Etikett RIPAGREEN
233442	Handgriffhälfte links + Etikett RIPAGREEN
239094	Standard Propangas Düse DIN
241019	Elektro-Anschlusskit RIPAGREEN
248110	Brennerkopf
248113	Gashahn, DIN
249064	Düsenhalterung komplett (Halterung, Düse, Verschluss) DIN
250132	Hochdruckschlauch 4 m. Ø 4 mit Klemmen und Anschlüsse DIN
250023	Hochdruckschlauch 8 m. Ø 4 mit Klemmen und Anschlüsse DIN
801xxx	Bedienungsanleitung RIPAGREEN
246139	Handgriff THERMOLANZE
333339	Thermolanzerohr
241026	Schraubensatz Wagen A
241027	Schraubensatz Wagen B
241028	Schraubensatz Wagen C
248202	Pannensicheres Rad
249084	Flaschengurt

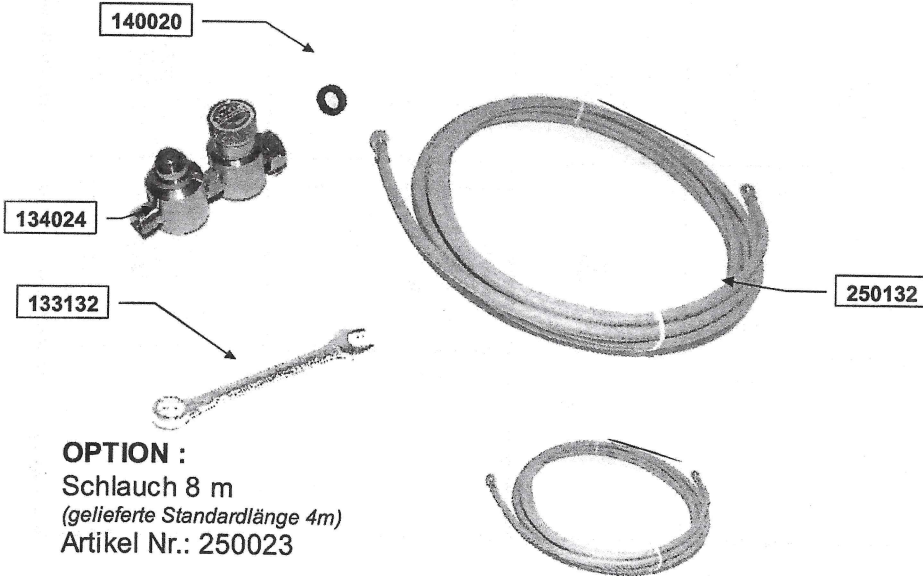

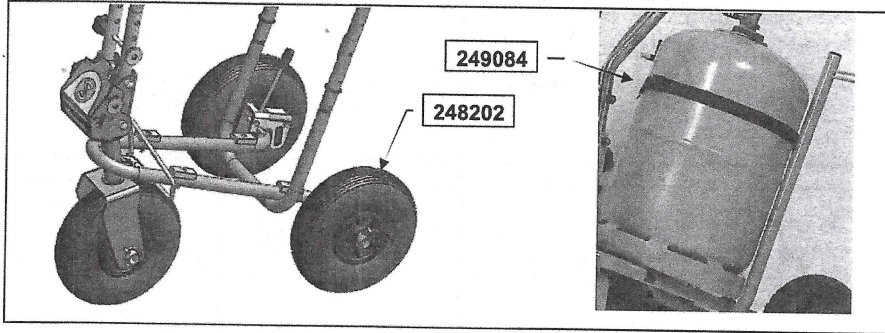
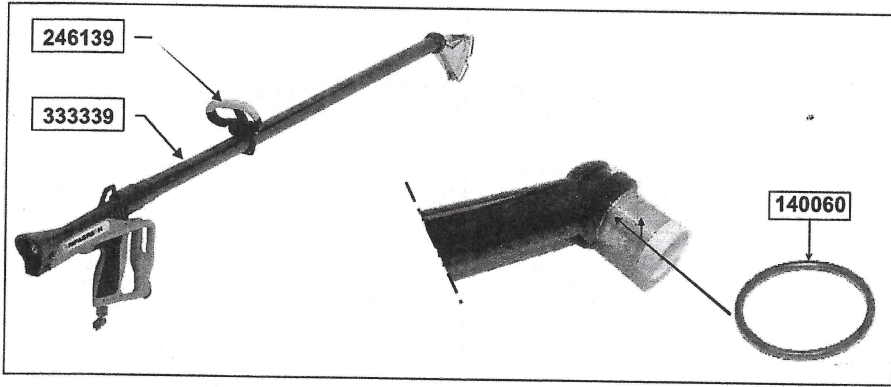



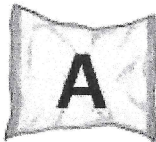



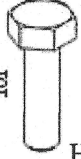
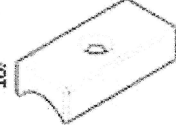

Artikel-Nr.	Bezeichnung
131003	Piezo Zünder für RIPAGREEN
131169	Bumper
133132	Kombischlüssel Schlauch-Druckregler 19 - 30
133403	Abzugshahn
133415	Inbusschlüssel 3
134024	SECURIPACK- DIN- einschließlich einstellbarem Druckregler und doppelter Sicherheit
137039	MOLYKOTE Fett
137081	Massen Stift
140020	Druckregler-Dichtung für SECURIPACK DIN
140060	O-Ring Dichtung für Verlängerungen - innen Ø 28.24 x Ø 2.62
140084	O-Ring Dichtung für Pistolenrumpf - innen Ø 34,82x3,53
145015	Düsenverschluss RIPACK SERIES 3000
148043	Drehgelenk
150153	Piezo Klappe
150154	Aluminium Gasrohr
152052	Inbus-Schraube CHc M4x16
152153	Inbus-Schraube CHc M4x35
232061	Zündkerze
233418	Pistolenrumpf mit O-Ringe
233419	Klinke + Feder
233441	Handgriffhälfte rechts + Etikett RIPAGREEN
233442	Handgriffhälfte links + Etikett RIPAGREEN
239094	Standard Propangas Düse DIN
241019	Elektro-Anschlusskit RIPAGREEN
248110	Brennerkopf
248113	Gashahn, DIN
249064	Düsenhalterung komplett (Halterung, Düse, Verschluss) DIN
250132	Hochdruckschlauch 4 m. Ø 4 mit Klemmen und Anschlüsse DIN
250023	Hochdruckschlauch 8 m. Ø 4 mit Klemmen und Anschlüsse DIN
801xxx	Bedienungsanleitung RIPAGREEN
246139	Handgriff THERMOLANZE
333339	Thermolanzerohr
241026	Schraubensatz Wagen A
241027	Schraubensatz Wagen B
241028	Schraubensatz Wagen C
248202	Pannensicheres Rad
249084	Flaschengurt

SATZ







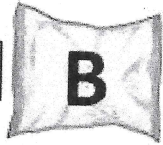

241026

 101 H M6x20	x2	 107	x4
 102	x4	 H M6x35	x2
 103	x2	 109	x2
 104	x2	 110	x3
 105 F M5x35	x4	 111	x2
 106 M5	x4		

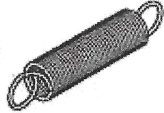



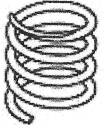

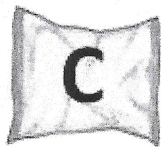

SATZ

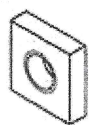

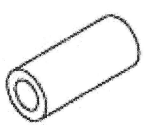
241027

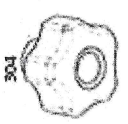
 201	x3	 206	x1
 202 M6	x2	 207	x1
 203	x2	 208 H M6x50	x1
 204	x4	 209 H M6x12	x1
 205	x4		

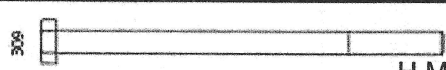
SATZ**241028**

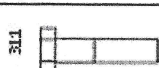
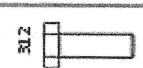
 301	x3	 305	x1
 302 M8	x4	 306	x1
 303	x2	 307	x2
 304	x2	 308	x6
 309		H M8x130	x1
 310		H M8x120	x2
 311		H M8x35	x1
 312		H M8x25	x1

Artikel-Nr.	Bezeichnung
131003	Piezo Zünder für RIPAGREEN
131169	Bumper
133132	Kombischlüssel Schlauch-Druckregler 19 - 30
133403	Abzugshahn
133415	Inbusschlüssel 3
134024	SECURIPACK- DIN- einschließlich einstellbarem Druckregler und doppelter Sicherheit
137039	MOLYKOTE Fett
137081	Massen Stift
140020	Druckregler-Dichtung für SECURIPACK DIN
140060	O-Ring Dichtung für Verlängerungen - innen Ø 28.24 x Ø 2.62
140084	O-Ring Dichtung für Pistolenrumpf - innen Ø 34,82x3,53
145015	Düsenverschluss RIPACK SERIES 3000
148043	Drehgelenk
150153	Piezo Klappe
150154	Aluminium Gasrohr
152052	Inbus-Schraube CHc M4x16
152153	Inbus-Schraube CHc M4x35
232061	Zündkerze
233418	Pistolenrumpf mit O-Ringe
233419	Klinke + Feder
233441	Handgriffhälfte rechts + Etikett RIPAGREEN
233442	Handgriffhälfte links + Etikett RIPAGREEN
239094	Standard Propangas Düse DIN
241019	Elektro-Anschlusskit RIPAGREEN
248110	Brennerkopf
248113	Gashahn, DIN
249064	Düsenhalterung komplett (Halterung, Düse, Verschluss) DIN
250132	Hochdruckschlauch 4 m. Ø 4 mit Klemmen und Anschlüsse DIN
250023	Hochdruckschlauch 8 m. Ø 4 mit Klemmen und Anschlüsse DIN
801xxx	Bedienungsanleitung RIPAGREEN
246139	Handgriff THERMOLANZE
333339	Thermolanzerohr
241026	Schraubensatz Wagen A
241027	Schraubensatz Wagen B
241028	Schraubensatz Wagen C
248202	Pannensicheres Rad
249084	Flaschengurt